

**EXPANDER
EG3014
USER'S
MANUAL**

Video Genie System

TABLE OF CONTENTS

	Page
1 Introduction	2
2 Setting Up	3
3 Power Up	4
4 Expanding Your Computer's Capability	5
5 Technical Informations	
I Parallel Printer Interface	6
II Mini-Floppy Disk Interface	8
III Memory	10
IV Bus Extension	11
6 Assembly Diagram	14

INTRODUCTION

The EG3014 Expander is designed to upgrade your Video Genie System to a more powerful microcomputer system, in the most convenient and economical way. The optional interfaces provide the flexibility of further expanding your computer's capability stage by stage. The cabinet design makes system connections simple, convenient and compact, and also provides an ideal support for your video monitor.

Most small microcomputer systems operate through their own system bus only, which would limit the expansion capacity. The Video Genie System can operate through both its own bus and the S-100 bus. The S-100 bus adaptor is an option. Also available optionally is a bidirectional RS232 interface.

General Functions Provided:

1. Hard Copy

The Parallel Printer Interface will operate with printers having Centronics compatible parallel interfaces, to provide hard copy print out.

2. Mass storage and fast access

The Disk Controller Interface can handle single or double side mini-floppy disk drives, and single or double track density storage option:

- i, single side with a maximum of 4 drives
double side with a maximum of 2 drives
- ii, track density: 35/40/77 tracks
- iii, Disk Operating System Options: TRSDOS, NEWDOS, NEWDOS 80, MICRODOS, VTOS or other compatible systems.

3. Memory Expansion

Memory capacity can be expanded from the basic 16K to 32K/48K by direct insertion of commonly available type 4116 RAM chips into the sockets provided on the board.

4. Optional Interfaces

i, Communication

Our RS-232-C Interface can be connected to telephone modem or other form of carrier to provide data communication capabilities. It can also be used to operate RS-232-C standard serial printers.

ii, Bus expansion

Our S-100 Bus interface provide slots for users to plug in standard S-100 Bus cards for further system expansion. The internal edge connector used to connect the S-100 bus interface can be used as an extension to the system bus.

SETTING UP

1. Remove the expansion connection-cover from the back of the computer.
2. Plug one end of the bus-cable (provided with the expansion unit) onto the card-edge of the computer, and the other end onto the left-most card-edge (50 pins) of the expansion unit, so that the cable is not twisted.
3. Peripheral connections:
 - i, **Parallel Printer**
Connect to the expansion unit via a printer cable, with the 34-pin edge connector plugged onto the rightmost card-edge. The connections on the top of the card-edge are odd-numbered pins, the signal-pins for the printer. On the bottom side of the card-edge there are even-numbered pins for return-ground.
 - ii, **Mini-floppy Disk Drives**
Connect to the expansion unit via a daisy chain cable, with the 34-pin edge connector plugged onto the middle card-edge. The connections on the top side are odd-numbered and are return-ground pins. On the bottom side the even-numbered pins are signal-pins.
4. After connecting up peripherals, put back the socket-cover onto the front panel of the expansion unit.

POWER UP

With all the connections of the peripherals properly done, get ready to turn on power to the whole system.

IMPORTANT NOTE: Never connect or disconnect the Computer and expansion peripherals while they are power ON.

Operating Procedures

1. Firstly, turn on power to the various peripherals.
2. Next, turn on power to the expansion unit.
3. Lastly, turn on power to the Computer.

Note: If there are no Floppy Disk Drives connected, the BREAK Key (on the Computer Keyboard) must be pressed down while turning on power to the Computer.

Similarly, the BREAK key must be pressed down simultaneously, if wish to press the RESET button to reset while the whole system is in use.

EXPANDING YOUR COMPUTER'S CAPABILITY

1. Memory Expansion

For every expansion unit, 16 sockets have been provided for expanding the memory from 16K to 32K/48K. Insertion of RAM chips (16K x 1 dynamic Ram, 250ns access time) into the sockets expands the memory size in step of 16K.

Procedure:

- i, Switch off the power to the expansion unit.
- ii, Take off the top cabinet by unscrewing the 5 screws from the bottom of the case.
- iii, There are two rows of 16-pin IC sockets (8 pieces on each row) on the left hand side of the P.C. Board. The left-most row is the space for highest memory, ie. last 16K block. Insert your RAM chips into the sockets in correct orientations.
- iv, Put back the top cabinet, the added memory is now ready for your use.

2. Optional Interfaces

When you take off the top cabinet of the expansion unit, you can see one 20-pin and one 50-pin edge connector on the underneath of the P.C. board.

- a, The 20-pin connector is for the connection to our RS-232-C Interface board, which facilitates data communication with other computers directly or through a telephone modem.
- b, The 50-pin connectors is primarily for the connection to our S-100 Bus Interface card. You can insert standard S-100 cards into the slots provided with the S-100 Interface card for further system expansion.
- c, Beside this, the 50-pin connector provide an extension of the system bus for use with custom interfaces which can be incorporated inside the cabinet.

TECHNICAL INFORMATIONS

I. Parallel Printer Interface

This Interface will operate with any printer which has a Centronics compatible parallel interface. In general, the printer should:

1. accept 7 – or 8 – bit ASCII data in parallel format.
2. supply the computer with the follow status signals:
 - i) BUSY – low = not busy, to send
 high = busy, not to send
 - ii) OUT OF PAPER – if the printer does not have this signal, ground
 this input to common ground.
 - iii) UNIT SELECT – if the printer does not have this signal, external
 resistor in the interface will automatically pull
 this input to high.

There are two statements for output to the printer in the computer's BASIC – LLIST, LPRINT. See Basic Reference Manual for details.

Note:

If no parallel printer is connected, LPRINT and LLIST will cause the computer in a dead loop and require you to reset it.

Two addresses have been assigned for the printer. One is I/O port FDH, and the other is memory address 37E8H. Either one can be used. The status bits are as follow:

<u>Bit</u>	<u>if set then status is</u>
7	BUSY
6	OUT OF PAPER
5	DEVICE SELECTED
4	ALWAYS HIGH

Connector Pin Assignment for Parallel Printer Interface:

PIN	SIGNAL	PIN	SIGNAL
1	DATA STROBE	2	GND
3	D0	4	GND
5	D1	6	GND
7	D2	8	GND
9	D3	10	GND
11	D4	12	GND
13	D5	14	GND
15	D6	16	GND
17	D7	18	GND
19	NC	20	GND
21	BUSY	22	GND
23	OUT OF PAPER	24	GND
25	UNIT SELECT	26	NC
27	NC	28	NC
29	NC	30	NC
31	NC	32	NC
33	NC	34	NC

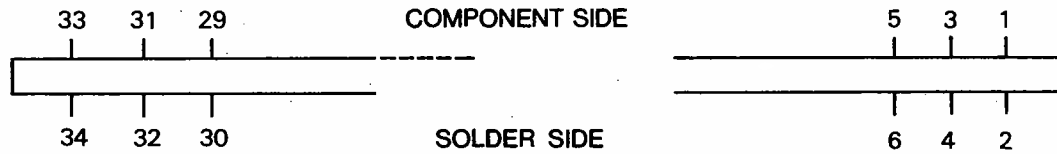

II. Mini-Floppy Disk Interface

This Interface can handle one to four Mini-Floppy Disk Drives, and is normally for single-sided drives. However, this can be adapted to double-sided drives. In this case one double-sided drive will replace two single-sided drives. SIDE SELECT signal is then controlled by DRIVE SELECT signals, ie. a maximum of two double-sided drives. Jumpers in position 2 and 4 at J5 (near the middle card-edge on the board) should be short-circuited. Meanwhile, drive select 1 and 3, and drive select 2 and 4 in disk drives should also be short-circuited respectively.

For single-sided drives:

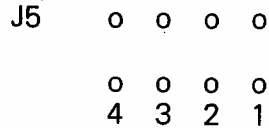

For double-sided drives:

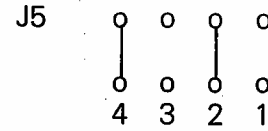

The address decoding scheme is:

SIGNAL GENERATED	SIGNAL TO	FUNCTION
37E0 READ	INTERRUPT LOGIC	READ INTERRUPT STATUS
37EC READ	FLOPPY DISK CONTROLLER	READ DATA FROM DISK CONTROLLER
37E0 WRITE	DRIVE SELECT	SELECT DRIVE 0 - 3
37EC WRITE	FLOPPY DISK CONTROLLER	WRITE DATA TO DISK CONTROLLER

This interface is designed for single-density format, using external data separation method to ensure higher reliability in data recovery.

The jumper configuration is as follow:

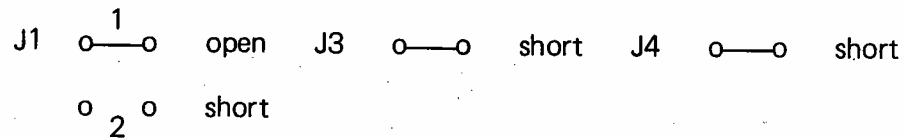

For internal data separation method, the jumper configuration should be:

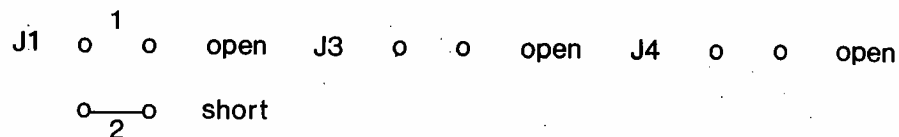

Connector pin assignment for Mini-Floppy Disk Interface:

PIN	SIGNAL	PIN	SIGNAL
1	GND	2	NC
3	GND	4	NC
5	GND	6	SIDE SELECT
7	GND	8	INDEX/SECTOR
9	GND	10	DRIVE SELECT 1
11	GND	12	DRIVE SELECT 2
13	GND	14	DRIVE SELECT 3
15	GND	16	MOTOR ON
17	GND	18	DIRECTION SELECT
19	GND	20	STEP
21	GND	22	WRITE DATA
23	GND	24	WRITE GATE
25	GND	26	TRACK 00
27	GND	28	WRITE PROTECT
29	GND	30	READ DATA
31	GND	32	DRIVE SELECT 4
33	GND	34	NC

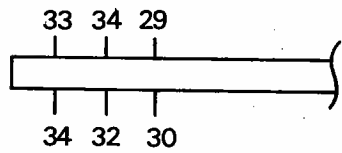

COMPONENT SIDE

SOLDER SIDE

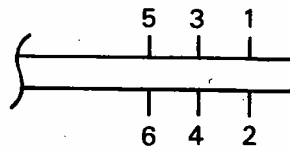

III. Memory

If you order an expansion unit without RAM, then connecting it to the computer will not affect the total amount of memory available in your system. Extra user's memory can be added in the expansion unit in steps of 16K, for a total of 32K, or 48K in the system.

The following map shows the memory addresses in various configurations:—

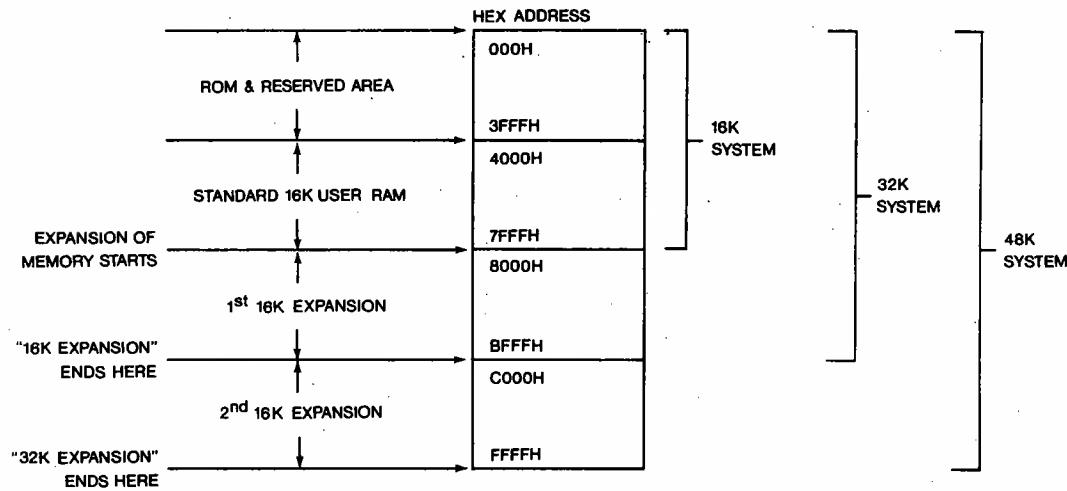

If you need to further increase the memory size beyond 48K, you can still achieve this by operating through our optional S-100 Bus Interface and inserting in standard S-100 RAM CARD which can provide bank select facility.

IV. Bus Extension

i) The pin assignment for the 50-pin connector is:

PIN	SIGNAL	ACTIVE LEVEL	DESCRIPTION
1	+16V		SEMI-REGULATED
2	CLOCK		2MHz, 50% DUTY CYCLE
3	-16V		SEMI-REGULATED
4	<u>MEMDIS</u>	L	HIGHEST 32K MEMORY DISABLE
5	+8V		SEMI-REGULATED
6	FX	L	RESERVED PORT ADDRESS
7	<u>D4</u>		DATA BIT 4
8	<u>INTA</u>	L	DATA IN ENABLE
9	BD6		DATA BIT 6
10	BD5		DATA BIT 5
11	BD \emptyset		DATA BIT \emptyset
12	BD7		DATA BIT 7
13	BD2		DATA BIT 2
14	BD1		DATA BIT 1
15	BA2	H	ADDRESS LINE 2
16	BD3		DATA BIT 3
17	BA \emptyset	H	ADDRESS LINE \emptyset
18	BA1	H	ADDRESS LINE 1
19	BA15	H	ADDRESS LINE 15
20	BA14	H	ADDRESS LINE 14
21	BA4	H	ADDRESS LINE 4
22	BA11	H	ADDRESS LINE 11
23	BA6	H	ADDRESS LINE 6
24	BA5	H	ADDRESS LINE 5
25	BA12	H	ADDRESS LINE 12
26	BA7	H	ADDRESS LINE 7
27	BA9	H	ADDRESS LINE 9
28	BA10	H	ADDRESS LINE 10
29	BA8	H	ADDRESS LINE 8
30	BA13	H	ADDRESS LINE 13
31	\emptyset		MASTER CLOCK, 1.8 MHz
32	BA3	H	ADDRESS LINE 3
33	<u>PHLDA</u>	L	PROCESSOR HOLD ACKNOWLEDGE
34	<u>PINT</u>	L	INTERRUPT REQUEST
35	<u>HALT</u>	L	PROCESSOR HALT ACKNOWLEDGE

PIN	SIGNAL	ACTIVE LEVEL	DESCRIPTION
36	<u>PHANTOM</u>	L	MEMORY DISABLE FOR BOOT-STRAPPING
37	<u>TORQ</u>	L	I/O REQUEST CYCLE
38	<u>PWAIT</u>	L	PROCESSOR WAIT CONTROL SIGNAL
39	<u>WR</u>	L	PROCESSOR WRITE CYCLE
40	<u>PHOLD</u>	L	PROCESSOR HOLD CONTROL SIGNAL
41	<u>CCDBS/STATDBS</u>	L	CONTROL SIGNALS AND STATUS DISABLE
42	<u>DODBS/ADDBS</u>	L	DATA OUTPUTS AND ADDRESS LINE DISABLE
43	<u>NMI</u>	L	NON-MASKABLE INTERRUPT
44	<u>RESET</u>	L	RESET CONTROL SIGNAL
45	<u>M1</u>	L	OP-CODE FETCH CYCLE
46	<u>RFSH</u>	L	REFRESH CYCLE
47	<u>MREQ</u>	L	MEMORY REQUEST CYCLE
48	<u>RD</u>	L	PROCESSOR READ CYCLE
49	GND		
50	GND		

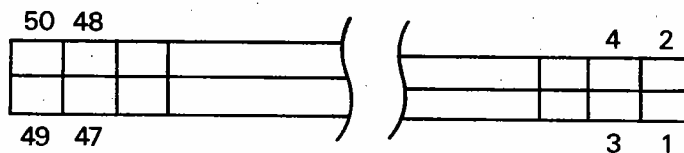

VIEWED FROM TOP SIDE

ii) The pin assignment for the 20-pin connector is:

PIN	SIGNAL	ACTIVE LEVEL	DESCRIPTION
1	BD5		DATA BIT 5
2	BD4		DATA BIT 4
3	BD7		DATA BIT 7
4	BD6		DATA BIT 6
5	BD1		DATA BIT 1
6	BD \emptyset		DATA BIT \emptyset
7	BD3		DATA BIT 3
8	BD2		DATA BIT 2
9	$\overline{\text{BWR}}$	L	PROCESSOR WRITE CYCLE
10	BA \emptyset	H	ADDRESS LINE \emptyset
11	$\overline{\text{BRD}}$	H	PROCESSOR READ CYCLE
12	$\overline{\text{SRESET}}$	L	SYSTEM RESET
13	8MHz \emptyset		8MHz, 50% DUTY CYCLE
14	SP*	L	SERIAL PORT SELECT
15	-16V		SEMI-REGULATED
16	$\overline{\text{PPR}}$	L	PARALLEL PRINTER PORT SELECT
17	+12V		REGULATED
18	+5V		REGULATED
19	$\overline{\text{SPR}}$	L	PARALLEL PRINTER DISABLE
20	GWD		GROUND

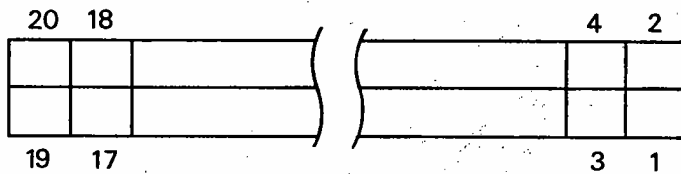

VIEWED FROM TOP SIDE

ASSEMBLY DIAGRAM

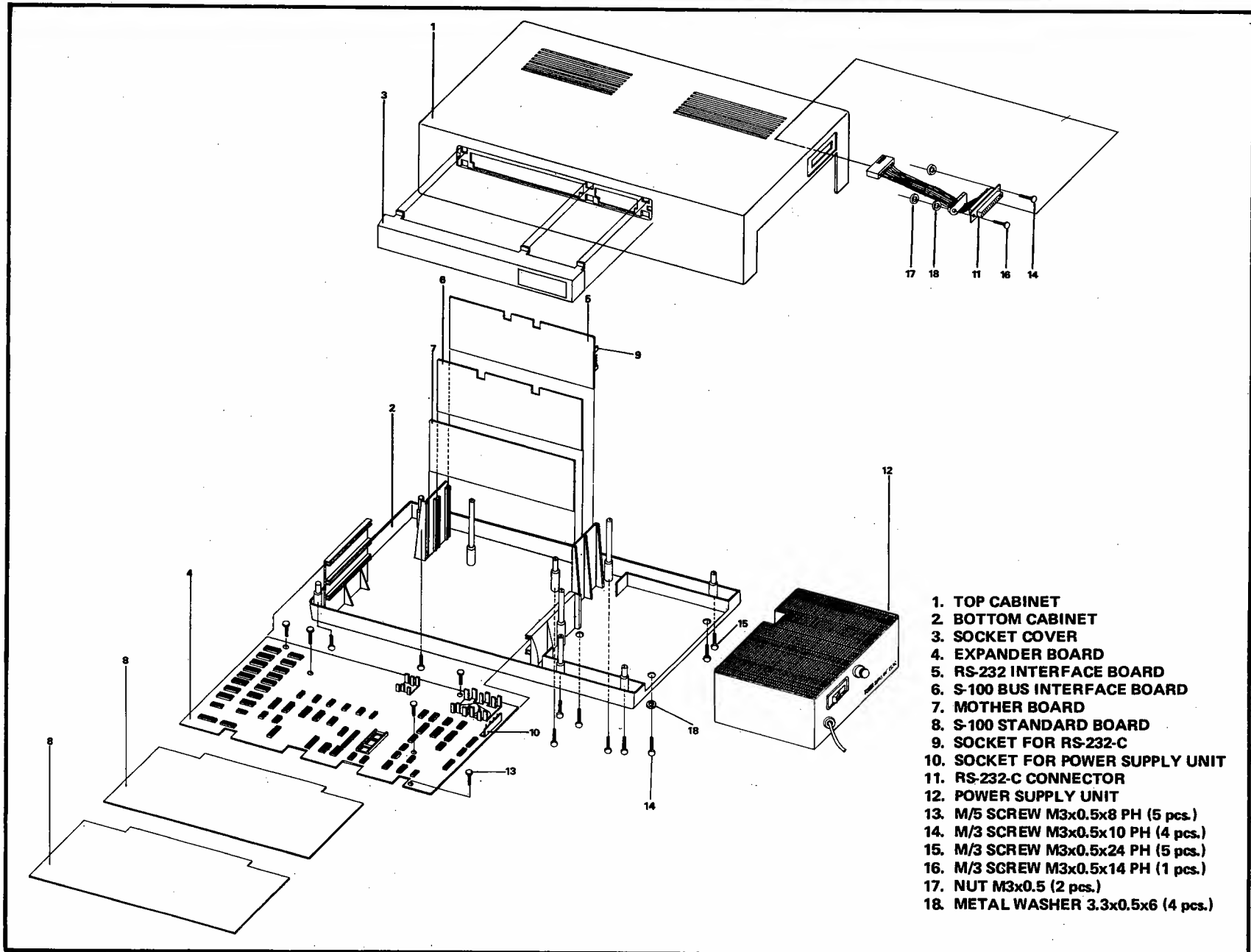

- 1. TOP CABINET
- 2. BOTTOM CABINET
- 3. SOCKET COVER
- 4. EXPANDER BOARD
- 5. RS-232 INTERFACE BOARD
- 6. S-100 BUS INTERFACE BOARD
- 7. MOTHER BOARD
- 8. S-100 STANDARD BOARD
- 9. SOCKET FOR RS-232-C
- 10. SOCKET FOR POWER SUPPLY UNIT
- 11. RS-232-C CONNECTOR
- 12. POWER SUPPLY UNIT
- 13. M/5 SCREW M3x0.5x8 PH (5 pcs.)
- 14. M/3 SCREW M3x0.5x10 PH (4 pcs.)
- 15. M/3 SCREW M3x0.5x24 PH (5 pcs.)
- 16. M/3 SCREW M3x0.5x14 PH (1 pcs.)
- 17. NUT M3x0.5 (2 pcs.)
- 18. METAL WASHER 3.3x0.5x6 (4 pcs.)

Eaca[®] INTERNATIONAL LTD.

13 Chong Yip Street, 1st Floor,
Kwun Tong, Kowloon, Hong Kong.
Eaca Industrial Building,
Telex: 84035 ECHK HX
Cable: "ECHUNG" H.K.
Tels: 3-896323 (8 Lines)
3-424151 (6 Lines)

**COPYRIGHT (C) BY EACA, 1981,
ALL RIGHTS RESERVED.**