

PLOTTER PRINTER

Catalog Number 26-1190A

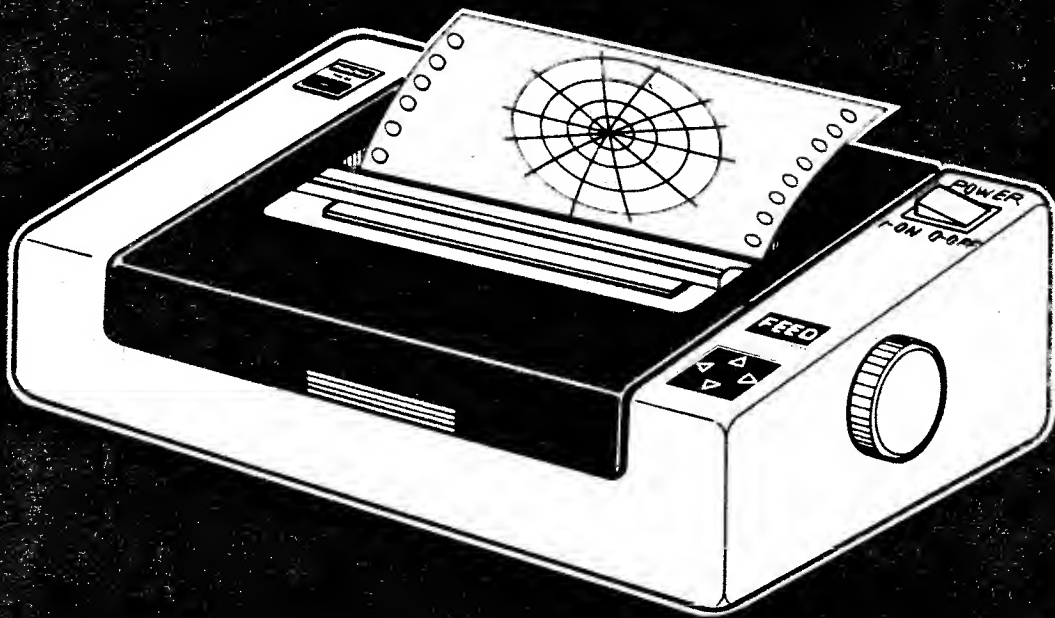

HARDWARE



CUSTOM MANUFACTURED IN THE USA FOR RADIO SHACK



A DIVISION OF TANDY CORPORATION

Congratulations for selecting this Radio Shack Computer product!

The TRS-80 Plotter Printer can be programmed with simple BASIC LPRINT statements to draw an infinite variety of points, lines and curves – as well as the standard ASCII text characters (excluding lowercase letters). The drawing mechanism is very simple, easy to maintain, and reliable. An easily replaceable ball-point pen is the writing device – no hammer, armature, or wire to wear out

Other exceptional features include:

- Fast-response solenoid control of the pen point assures precision drawings.
- Ballpoint pen produces clean, clear, reproduceable copies.
- Compact, lightweight design.
- Character size can be controlled by software (twice, four times, or eight times normal size).
- Alphanumeric characters can be rotated 90, 180, or 270 degrees (software controllable).
- Two modes of operation – plotter and character – software selectable.
- Built-in programming simplifies the drawing of many geometric shapes.
- Ultra-simple control mechanism (two motors and one magnet) means fewer moving parts – resulting in superior reliability and low-noise operation.
- Modular design and construction combined with a mechanism which requires no lubrication keeps service and maintenance to a minimum.

CONTROLS AND FUNCTIONS

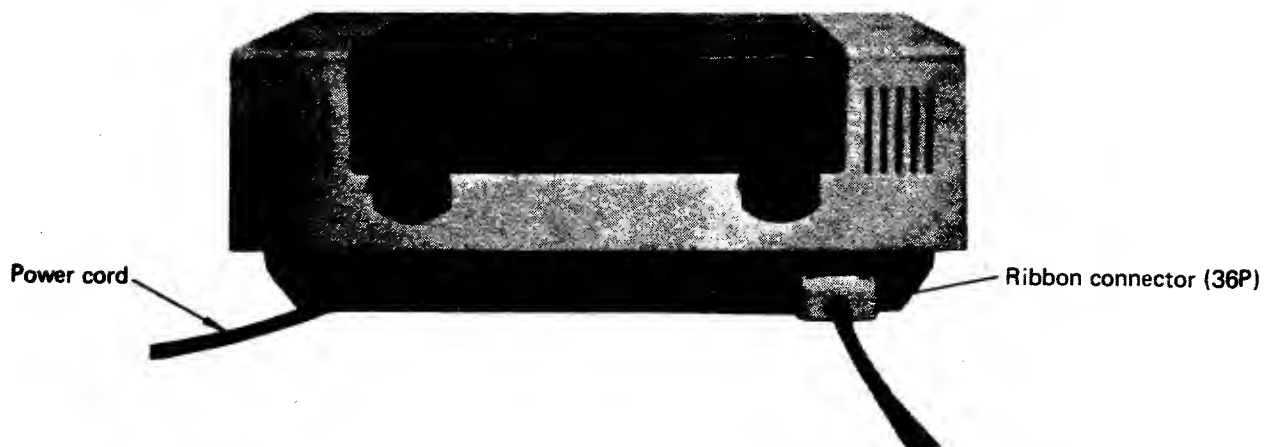
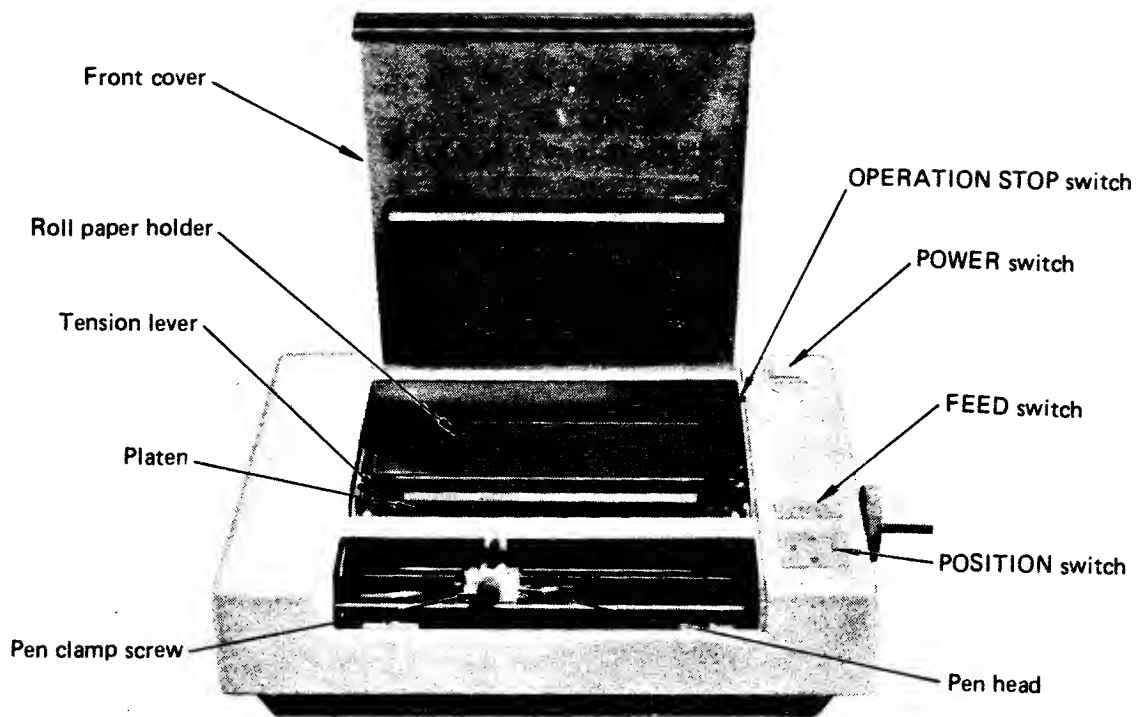

SETTING UP

Loading the Paper

1. Open the plastic cover.
2. Place a roll of paper in the compartment behind the platen with the paper coming off the bottom of the roll.
3. Pull the tension lever forward and thread the paper under the platen and behind the paper guide.
4. Align the paper holes over the sprockets on the platen and return the tension lever to its original position.

Setting the Ballpoint Pen

1. Loosen the pen clamp screw.
2. Insert the pen into the pen holder and tighten the pen clamp screw.

Note: Be sure to test the pen first before inserting it, as the pen tip may be dry. Also, any time that you use the Plotter Printer after it hasn't been used recently, slip a piece of scrap paper between the pen and the platen and smear it against the pen tip to get the ink flowing.

Thread the paper up through the slot in the plastic cover and close the cover.

Firmly attach the connector provided to the back of the Plotter Printer.

Plug the power cord into a source of 120 volts, 60 Hz AC power (220/240 VAC for European and Australian models).

Your Plotter Printer is ready for use.

OPERATION

POSITION Switch: Press the appropriate arrow to move printing position. For continuous movement, hold down for 1/2 second.

- Notes:**
1. Don't push the switch while the Printer is operating.
 2. When changing the direction of movement, release the switch for a moment to allow the pen head to stop, and then press the desired direction arrow.
 3. While this switch is down, a busy signal is sent to the Computer.
 4. This switch only functions to move the pen (it does not engage the pen against the paper). If the switch is operated while the pen is "on", the pen will be set to "off" before it is moved.
 5. The coordinates of the pen position will be the same. The coordinate system is shifted along with the pen.

FEED Switch: Press to advance paper.

- Notes:**
1. Don't push the switch while the Printer is operating.
 2. While this switch is down, a busy signal is sent to the Computer.
 3. This switch only functions to move the paper. If the switch is operated while the pen is "on", the pen will be set to "off" before the paper is advanced.

Range of Movement by POSITION Switch

The illustration below shows the limits of pen movement using the POSITION Switch.

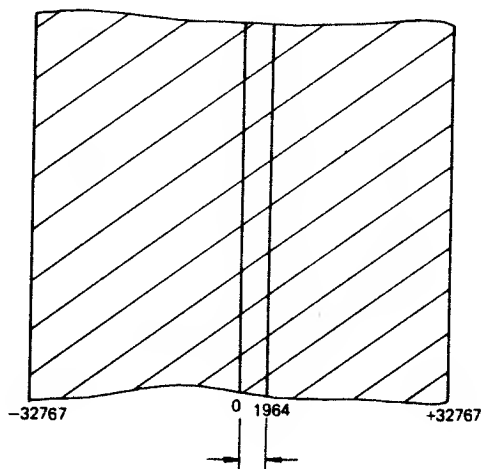

X-axis: -32767 to $+32767$

Y-axis: no limit

Movement speed: 0 to $+32767$ Plotter mode = approx 33 sec
Character mode = approx 50 sec
0 to -32767 Plotter mode = approx 28 sec
Character mode = approx 45 sec

Note: The pen will physically move only over an X axis length of 1964 steps, which is the width of the paper. If you continue to press the POSITION switch the pen will stop at the edge of the paper, but the Plotter Printer will internally keep the pen's "imaginary position" as if it is still moving. The imaginary position can be anywhere between -32767 and $+32767$.

Interlock Switch (inside the unit, next to the cover)

When the cover is opened, the following occurs:

1. The operation stops.
2. A Busy status exists and no data can be received.
3. The POSITION and FEED switches become inoperative.

When the cover is closed operation continues from its previous status.

PROGRAMMING

Note: All of the sample programs are written in BASIC. The apostrophe signifies a remark, material that you don't need to type in.

Incremental Stepped Pen Motion

The pen does not move in one continuous line; it is digitally controlled in increments of 0.09525 mm (approximately .004 inch). Effective paper width is 1964 steps, or 187 mm (7-3/8").

Note: Each movement of the POSITION switch moves printing position by 10 steps (increments) in the direction of the arrow pressed.

Mode Change

The Printer has two modes of operation: Character Mode and Plotter Mode. Control Code 1 sets to C mode (Character); Control Code 2 sets to P mode (Plotter).

Note: On power-up, the Printer is automatically set to C mode.

```
10 LPRINT CHR$(2) :           'SETS TO P MODE
20 LPRINT "G50 X750 Y190" :   'MOVE PEN TO POINT 750, 190
30 LPRINT CHR$(1) :           'SETS TO C MODE
40 LPRINT "PLOTTER PRINTER" : 'PRINTS MESSAGE
```

The above sample program will print PLOTTER PRINTER from the X, Y position defined as 750,190. We'll explain line 20 later.

Character Mode (C Mode)

In the C mode the Printer prints the standard ASCII alphanumeric and symbols. The internal buffer stores up to 14 characters.

CAUTION: Printing is made in capital letters even when small letters (26 letters a through z) specifying codes are input. The printer passes other codes when they are input. (They are neglected and it does not function.)

Character Size

The base scale provides the following sizes:

Character spacing	24 steps (approx 11 characters/inch)
Line feed spacing	44 steps
Character width	16 steps (varies depending on character)
Character height	30 steps (varies depending on character)

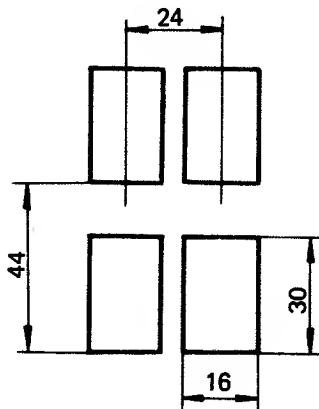

Note for Model II users: During printing operations the Plotter Printer will be busy; this may result in "Printer Not Ready" errors. To prevent this, you may need to insert pauses in your program after long-printing instructions. See line 55 in the next program.

Changing the Character Size

The size of the characters can be changed via control codes as follows:

Code (decimal)	Size
3	All following characters will be twice base size.
4	All following characters will be four times base size.
5	All following characters will be eight times base size.
6	All following characters will be base size (this is the initial size, automatically set on power-up).

Example:

```
10 LPRINT CHR$ (1);           'SETS TO C MODE
20 LPRINT CHR$ (3) "TWICE BASE SIZE"
30 LPRINT CHR$ (2)           'SETS TO P MODE
40 LPRINT "G50 U0 V-200"     'MOVE DOWN 200 STEPS
50 LPRINT CHR$ (1) CHR$ (4) "FOUR TIMES BASE"
55 INPUT "PRESS <ENTER> AFTER PRINTING IS FINISHED"; X
60 LPRINT CHR$ (2)           'SETS TO P MODE
70 LPRINT "G50 U0 V-400"     'MOVE DOWN 400 STEPS
80 LPRINT CHR$ (1) CHR$ (5) "8 TIMES"
90 LPRINT CHR$ (6) "BACK TO NORMAL AGAIN"
```

Model I and III users may delete line 55. Model II users see previous Note.

Rotating Characters

The orientation of the writing can be set for 0°, 90°, 180°, or 270° via control codes as follows:

Code (decimal)	Rotation (degrees)
17	0 (normal upright position) This is the initial state.
18	90 (reading from the left side)
19	180 (upside down)
20	270 (reading from the right side)

ENLARGED LETTERS AND TURNED LETTERS

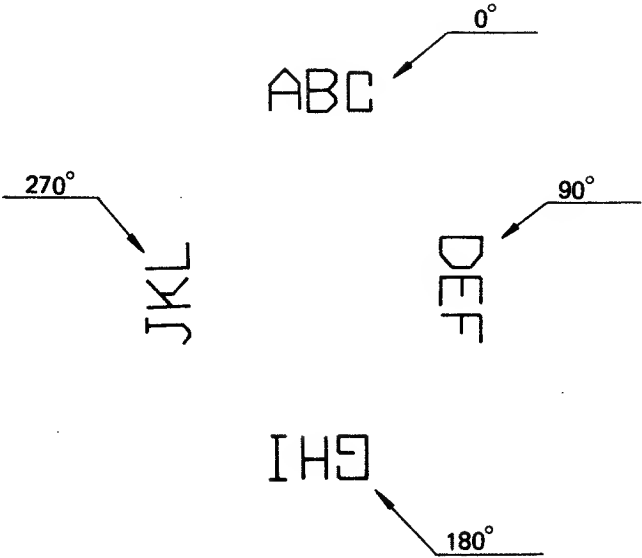
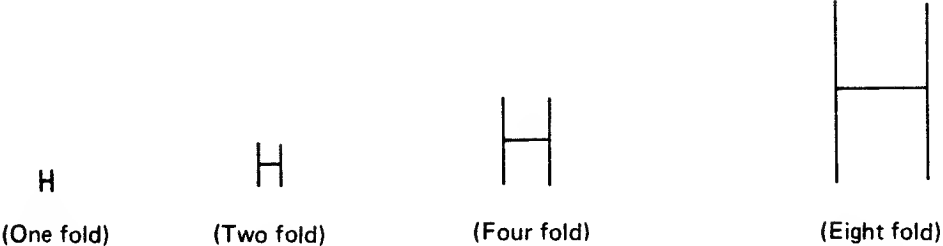

Example:

```
10 LPRINT CHR$ (2)
20 LPRINT "G50 X1500 Y190" 'MOVING PRINT POSITION
30 LPRINT CHR$ (1) CHR$ (18) "90 DEGREE PRINTING";
40 LPRINT CHR$ (2)
50 LPRINT "G50 U-300 V-300" 'MOVING PRINT POSITION
60 LPRINT CHR$ (1) CHR$ (19) "180 DEGREE PRINTING";
70 LPRINT CHR$ (2)
80 LPRINT "G50 U-300 V300" 'MOVING PRINT POSITION
90 LPRINT CHR$ (1) CHR$ (20) "270 DEGREE PRINTING";
100 LPRINT CHR$ (2)
110 LPRINT "G50 U400 V300" 'MOVING PRINT POSITION
120 LPRINT CHR$ (1) CHR$ (17) "BACK TO NORMAL"
```

Note: When changing from P-mode to C-mode, the Rotation and Character-size states are automatically reset to 0 degrees and base size, respectively.

Other Control Codes

The Printer accepts the following additional codes and ignores all others:

- | | |
|----|------------------------------------|
| 8 | Backspace by one character (BS) |
| 10 | Linefeed (LF) |
| 13 | Carriage return with linefeed (CR) |

Note: Input character automatic return function is equipped on the Plotter Printer. 81st character and subsequent are printed in the next line.

Pen Positioning (Alphanumeric mode)

1. At rest the pen is positioned in the center of a character.

Example: After A is printed, the pen moves to the position ① . (24 steps from the center of "A").

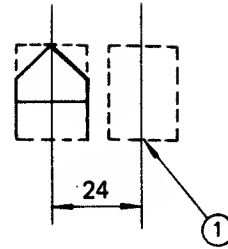

2. If the Printer receives a full line of printable characters without a carriage return, it will perform an automatic line advance upon receipt of the next printable character.

This is called wraparound, since the text automatically wraps to the next line without loss of characters. At 81st position of one-fold character wraparound takes place.

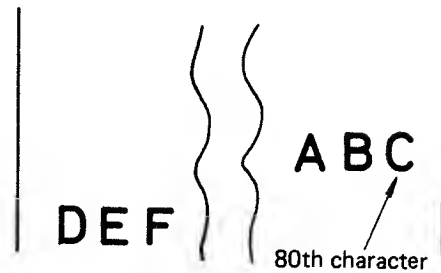

3. When a BS (Back Space, CHR\$ (8)) is input for more than the number of spaces to the left margin, the pen will move to the left margin, then the imaginary pen point will be internally set as though it were at an imaginary position represented by the BS spacing.

Example: When BS is input three times after A is printed, the pen will be internally set to the equivalent of "imaginary" position ③ .

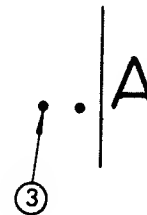

Pen Position on Power-up or with CR Code Input

The pen moves to the right by a half-character space and then will write the first character transmitted.

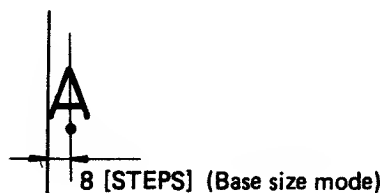

Function of CR Code

When a CR Code is input, the pen moves to the left margin and will begin printing in that position.

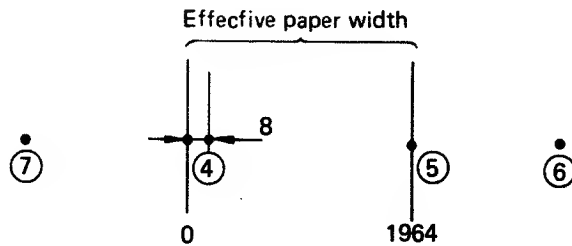

Whenever a CR Code is input, regardless of pen position – at (5) or “imaginary positions” (6) or (7), the pen will return to position (4).

Example: When in the P Mode the pen is set to (3500, -1000) and then C Mode and CR are input, the pen will move as illustrated.

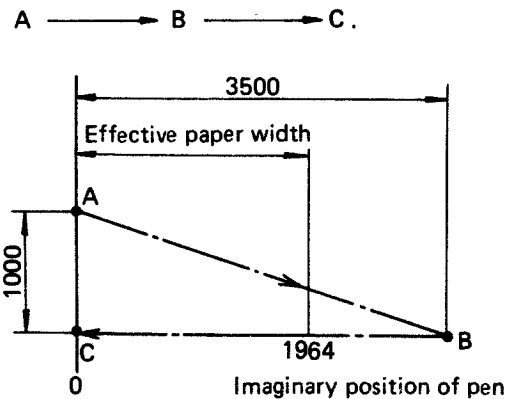

CR Timing Considerations

When the pen is positioned at the imaginary points D or E and a CR code is input, it will take approximately three seconds before the pen moves to the left margin. (The process “thinks” the pen is at that position and will calculate motions accordingly.) It will take approximately 400 mS for the pen to return to the left margin when automatic return is made at the 80th character.

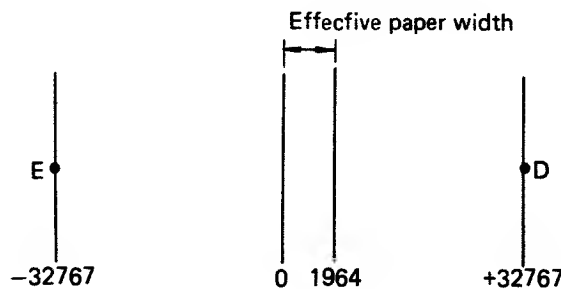

Note: In the rotated character mode, CR functions just as normal, but LF does not. That is, CR causes the pen to move to the left margin. LF, if in the 90 and 270 modes, will be ignored. In the 180 mode, LF feeds paper in reverse.

Plotter Mode (P Mode)

In the Plotter mode, the printing position is determined by a system of coordinate values. If a command tells the pen to move to a point off the paper, the pen will remain stationary at the paper's edge, but the pen's imaginary position off the paper will be kept internally and the next move or print will start at that imaginary position.

Absolute Coordinate System

The coordinate axes are defined with respect to the paper as follows:

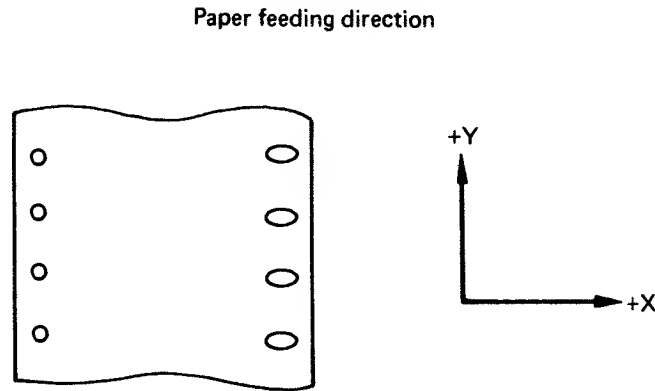

When the mode is set to P Mode the reference point for the absolute coordinate system is as follows if the POSITION switch is not used.

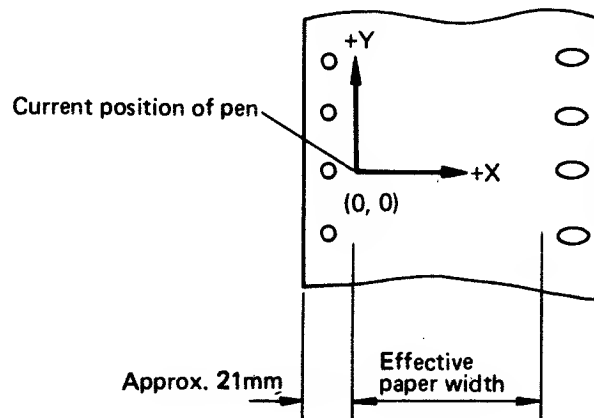

The zero-point of the X axis ($X=0$) is defined as the left margin. The zero-point of the Y axis ($Y=0$) is defined as the current pen position.

Relative Coordinate System

The relative coordinate values, compared with the current position of the pen, are determined as follows:

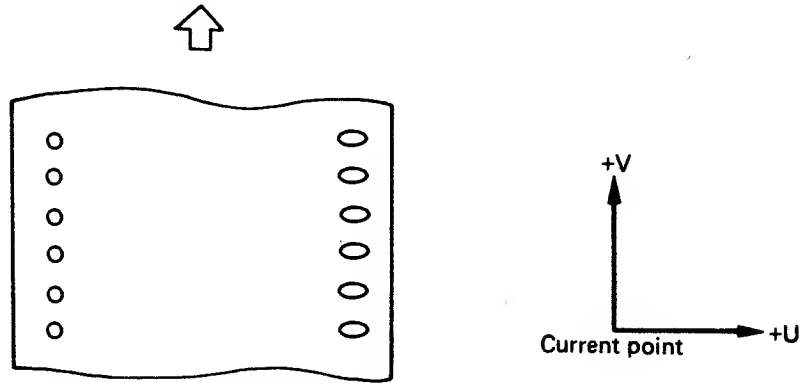

(X, Y) value and (U, V) value agree only when the pen is in the original position (0, 0).

You can change the location of the origin position by using the POSITION and/or the FEED switch.

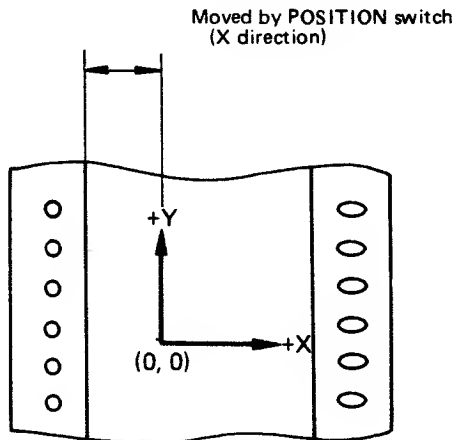

Remember that the X and Y coordinates move with the pen when the POSITION or FEED switch is used. Thus, when these switches are pressed the absolute origin and the absolute coordinate system also shift with the pen.

Example:

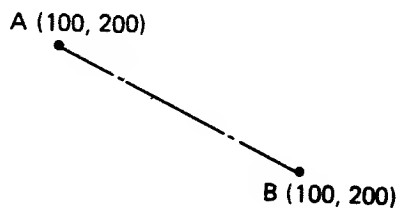

When the pen is moved from A to B with the POSITION switch, the new coordinate value of B becomes the original coordinate value that A had (100, 200).

The origin can also be moved by use of the G02 and G03 commands (See page 17).

G Functions

G Functions control the action of the pen and the paper. These control statements consist of the ASCII character "G" plus a series of ASCII numbers and letters defining the line and/or figure segments desired.

There are seven G functions as noted below:

G Function Table

G Code	Function	Remarks
G00	Straight line segment	Dotted Line
G01	Straight line segment	Solid Line
G02	Arc segment (drawn clockwise)	Solid Line
G03	Arc segment (drawn counter-clockwise)	Solid Line
G50	Pen up movement	
G90	Rectangular figure	Solid Line
G91	Triangular figure	Solid Line

G00 Function: Draws a dotted line between the current point and the point specified by the X and Y coordinates.

Format: G00 Xnn Ynn CR

Example: LPRINT "G00 X800 Y500"

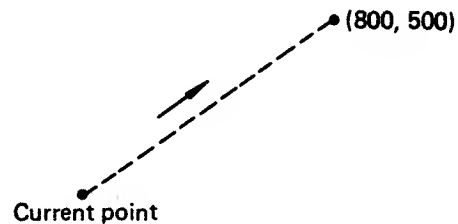

G01 Function: Draws a solid line between the current point and the point specified by the X and Y coordinates.

Format: G01 Xnn Ynn CR

Example: LPRINT "G01 X1000 Y1200"

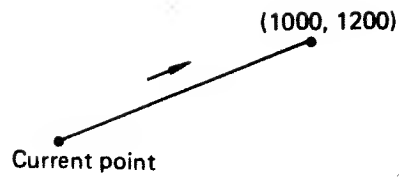

G02 Function: Draws an arc in a clockwise direction between the current point and the point specified by the X and Y axes. The center of the arc is specified by I and J, which show the coordinate distance of the current point on the X axis and Y axis to the center point.

Format: G02 Xnn Ynn Imm Jmm

Example: LPRINT "G02 X600 Y200 I200 J346"

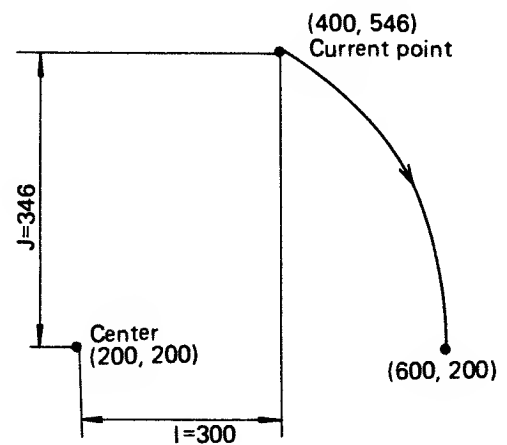

The value of I is the distance on the X axis from the current point to the center point. The value of J is the distance on the Y axis from the current point to the center point. One complete circle is drawn by specifying only I and/or J.

Example: LPRINT "G02 I200 J200"

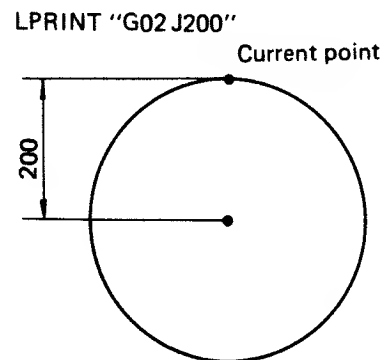
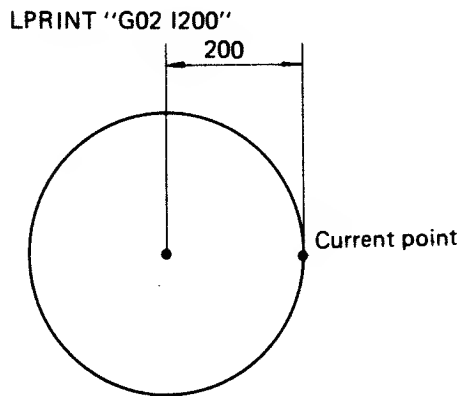

Even when the X and/or Y coordinate of the point specified is not present on a circumference (determined by the current point and the center point (I, J)) the pen moves to the point specified. However, when both coordinates of the point specified are outside the radius of the circle, the pen will move along a maximum of 1-1/2 times the circumference and then stop. Under this condition, the relative relationship between the Absolute coordinate value and the pen position will be lost.

Example for when the point specified by X, Y (U, V) is not present on the circumference (but is inside the radius of the specified circle):

LPRINT "G02 U-300 V-300 I400 J"

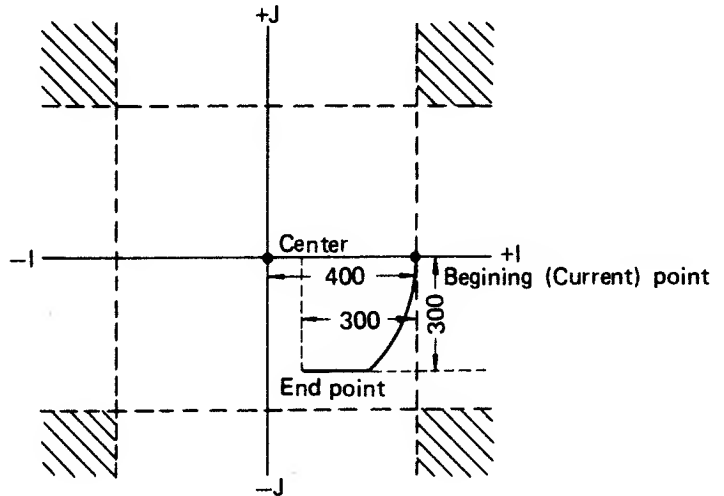

Example for when both coordinates of the point specified are outside the radius of the circle (shaded areas):

LPRINT "G02 U100 V500 I400 J"

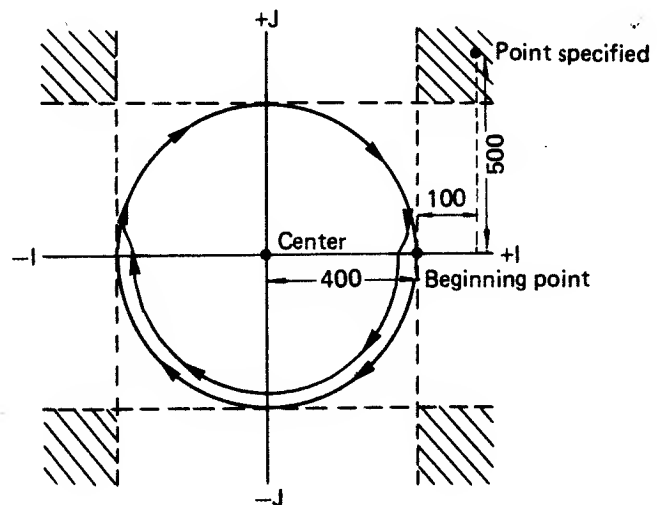

One special application of G02 (or G03) is to move the coordinate origin. When "G02 X0 Y0" (or "G03 X0 Y0") is executed, the current pen position becomes the new origin.

Example:

1Ø LPRINT "GØ1 X2ØØØ Y1ØØØ"

2Ø LPRINT "GØ2 XØ YØ":

'POINT (2000, 1000) BECOMES NEW ORIGIN

3Ø LPRINT "GØ1 X1ØØØ Y-1ØØØ":

'POINT DESIGNATION FROM NEW COORDINATE

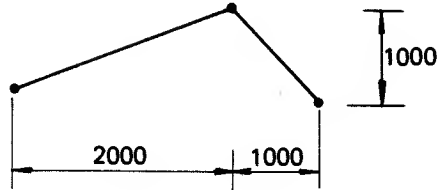

GØ3 Function: Functions the same as GØ2, but draws in a counter-clockwise direction.

Example: LPRINT "GØ3 X2ØØ Y6ØØ I3ØØ J265"

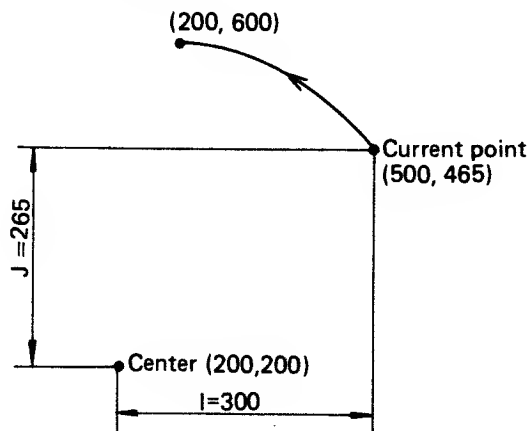

G5Ø Function: Lifts the pen and moves it from the current point to the coordinate point specified.

Example: LPRINT "G5Ø X6ØØ Y7ØØ"

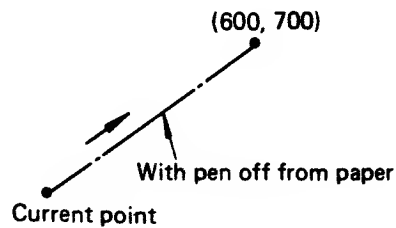

G90 Function: Moves and draws a line first to the specified Y coordinate, then to the X coordinate, then to the original Y coordinate, and then back to the start point. Thus a rectangle can be defined by the positions of two of its diagonal corners. (One of them being the current pen position.)

Example: LPRINT "G90 X300 Y900"

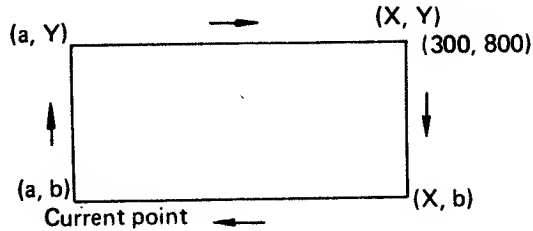

The pen moves and draws a line from the current pen position (a, b) to (a, Y) to (X, Y) to (X, b) and then back to (a, b).

G91 Function: Moves and draws a line to (a, Y), then to (X, b), and then to the starting point (a, b), creating a triangular shape.

Example: LPRINT "G91 X1000 Y1300"

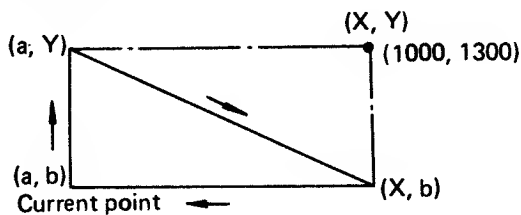

Note on G Functions

When a G function code is not specified, any previously specified G function will continue.

Example: LPRINT "G00 X800 Y400" : LPRINT "X1000 Y200"

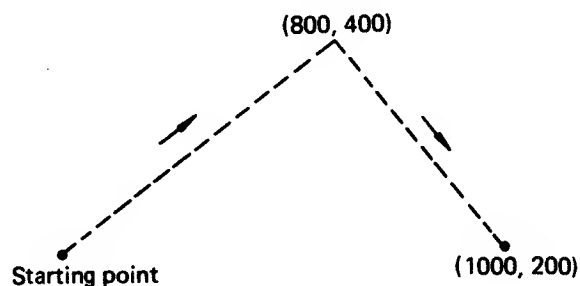

M Function: When `M00 CR` is input, the pen moves from the current point to the origin of the absolute coordinate system.

Example: `LPRINT "M00"`

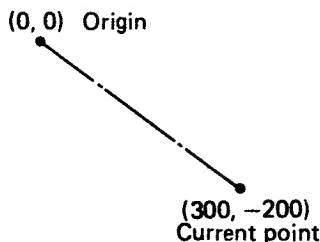

Combining P Mode and C Mode

When changing to the P mode, the current position of the pen becomes the origin of the Y-axis ($Y=0$). (In the C mode, the absolute coordinate value in the Y direction is not stored.)

Example: `10 LPRINT CHR$ (2)`
`20 LPRINT "G01 X500 Y-500"`
`30 LPRINT CHR$ (1) CHR$ (32) "A" CHR$ (8) CHR$ (8).`
`40 LPRINT CHR$ (2)`
`50 LPRINT "G01 X1000 Y-500":`

Note regarding line 30: `CHR$ (32)` is a space code; without it, letter "A" would be printed right on the point. `CHR$ (8)` is a back-space code to compensate for the normal movement to the right caused by the space code and "A". The pen moves twice (four or eight times) in an enlarged mode, therefore use the appropriate number of back-space codes to compensate.

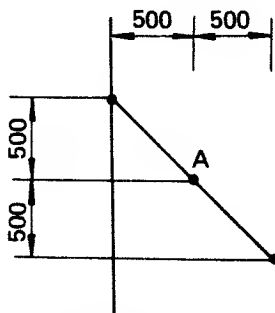

Note that X axis is not changed during mode change-over.

Input Format

After a G function code is input, X, Y, U, V, I, and J can be used in any order.

Examples: LPRINT "G01 Y100 X100" is the same as
LPRINT "G01 X100 Y100"
LPRINT "G02 V200 U200 J-100 I-100" equals
LPRINT "G02 I-100 U200 J-100 V200"

The absolute coordinate value and relative value may be used simultaneously.
However, when X and U, and Y and V are used simultaneously, only the earlier input is valid.

Examples: LPRINT "G00 X100 V-500"
LPRINT "G00 U100 Y-500"
LPRINT "G00 X100 U500 Y200" U500 will be invalidated
LPRINT "G00 U200 V500 Y300" Y300 will be invalidated

Handling of Invalid Codes

When using G00, G01, G50, G90, or G91:

Gmm . . . X(or U) . . . (12345) . . . Y(or V) . . . (12345) . . . CR
(1) (2) (3) (4) (5)

The following codes are ignored when input in positions 1 through 5 :

- 1 --- Codes other than G, X, Y, U, V, and CR
- 2 & 4 Codes other than +, -, digits, and CR
- 3 --- Codes other than X (U), Y, V, digits, and CR
- 5 --- Codes other than Y (V), digits, and CR

Example: LPRINT "G01 AA X AA 2000 AA Y AA 1500 AA"

is the same as

LPRINT "G01 X2000 Y1500"

When using G02 or G03:

Gnn ... X(or U) ... (12345) ... Y(or V) ... (12345) ... I ... (12345) ... J ... (12345) ... CR
(6) (7) (8) (9) (10) (11) (12) (13) (14)

The following codes are ignored when input in positions 6 through 14 :

- 6 --- Codes other than G, X, Y, U, V, I, J, and CR
- 7, 9, 11, 13 --- Codes other than +, -, digits, and CR
- 8 --- Codes other than X (U), Y, V, I, J, digits, and CR
- 10 --- Codes other than Y (V), I, J, digits, and CR
- 12 --- Codes other than I, J, digits, and CR
- 14 --- Codes other than J, digits, and CR

Example: LPRINT "G02 BB X BB 500 BB Y BB 500 BB I BB 500 BB J BB 500 BB"
is the same as
LPRINT "G02 X500 Y500 I500 J500"

Range of Values:

Values of U and V are valid within the range of -32767 to +32767.
Values of X, Y, I, and J are valid within the range of -16383 to +16383. (0 value must not have a minus sign.)

CAUTION: If a value outside the range of -32767 to +32767 is input, the value is assumed to be 0.

Example: LPRINT "G01 X40000" at point A causes the pen to move to point B.

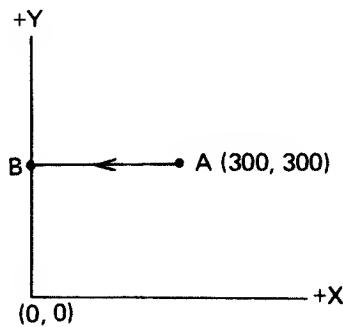

Input Correction

G Functions

When Gmm is to be corrected to Gnn, input Gnn immediately after inputting Gmm.

Example: Changing G01 to G50, "G01G50 X1000"
will function just like "G50 X1000"

Other values (X, Y, U, V, I, and J)

When Xmm is to be corrected to Xnn, input Xnn immediately after Xmm (the second value will be used).

Example: Changing X10000 to X20000, "G01 X10000 X20000"
will function just like "G01 X20000".

Y, U, V, I, and J can be corrected in the same way.

Relative Coordinate System

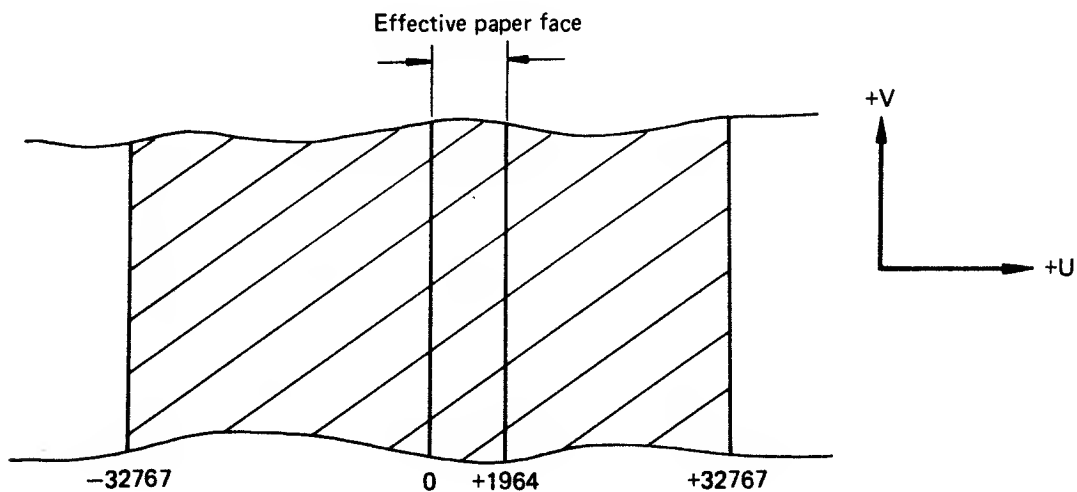

When plotting characters or illustrations, the pen position (whether actual or imaginary) must stay within the limits represented by shading in the above figure. This refers to the cumulative pen motion, not only the motion for one command.

For the X-direction, stay within the range of -32767 to $+32767$.

For the Y-direction, the pen motion is limited only by the length of your paper roll.

If an attempt is made to draw a figure or character outside the shaded area, the relationship with the relative coordinate system will be lost. (The mathematical location of the origin will be deleted, leaving no reference point for the coordinate system.)

Example: When `G01 U400 V200` is input at point A, to move the pen to point B, the relationship with the relative coordinate system will be lost.

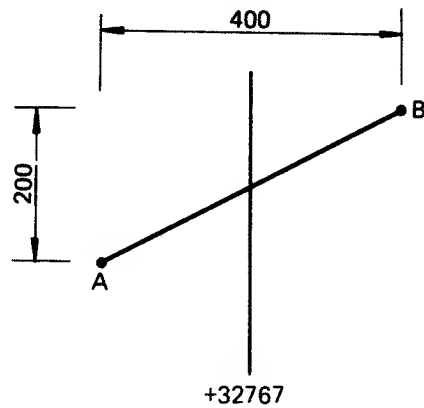

Absolute Coordinate System

When the origin in the X-axis is on the left margin:

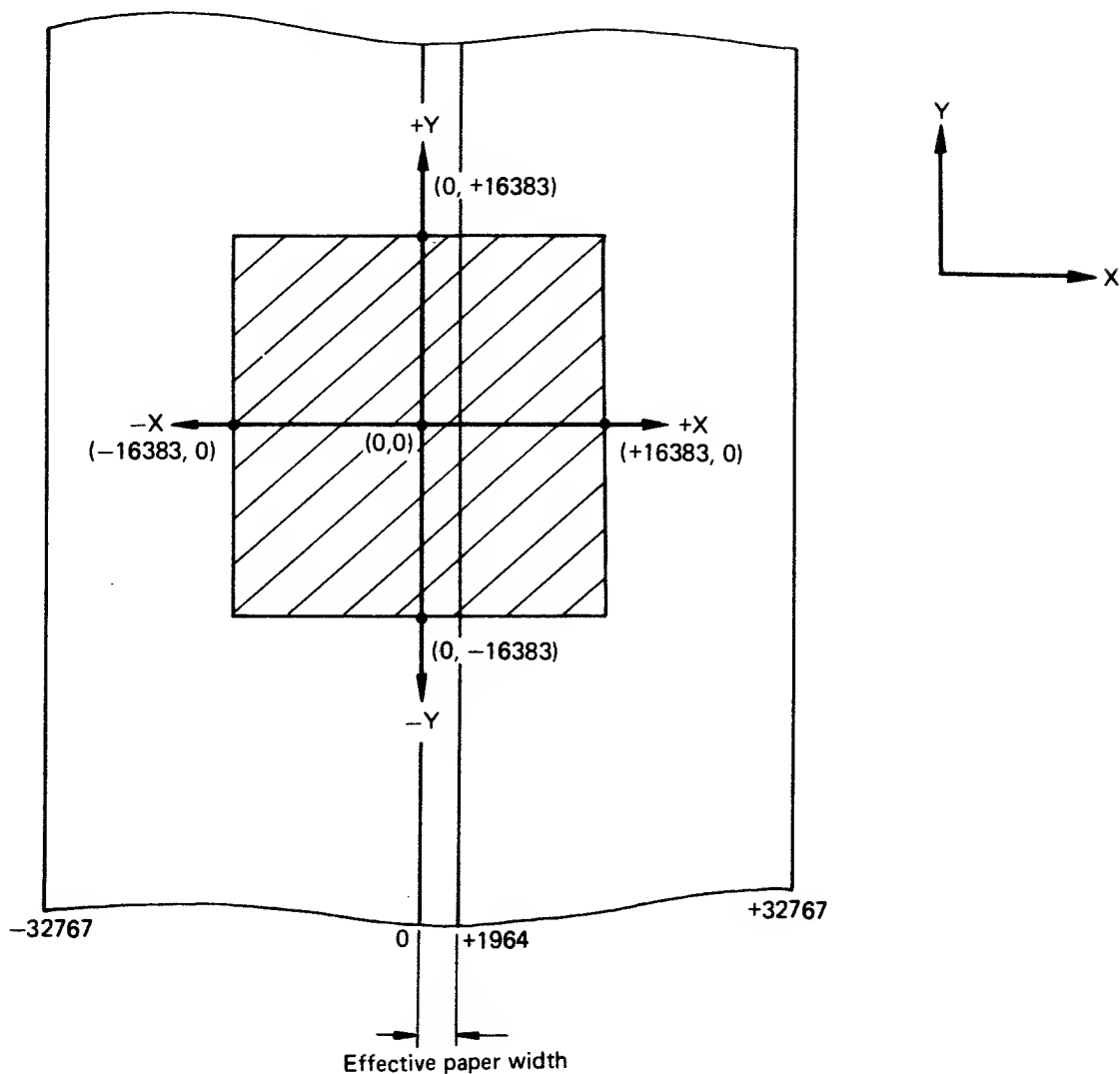

When drawing characters or illustrations, use only the area represented by shading in the above figure. If an attempt is made to draw a character or illustration outside the shaded area, the relationship with the absolute coordinate system will be lost.

Example: When "G01 U-20000 Y1000" is input to move the pen from the origin to point D, the relationship with the absolute coordinate system will be lost.

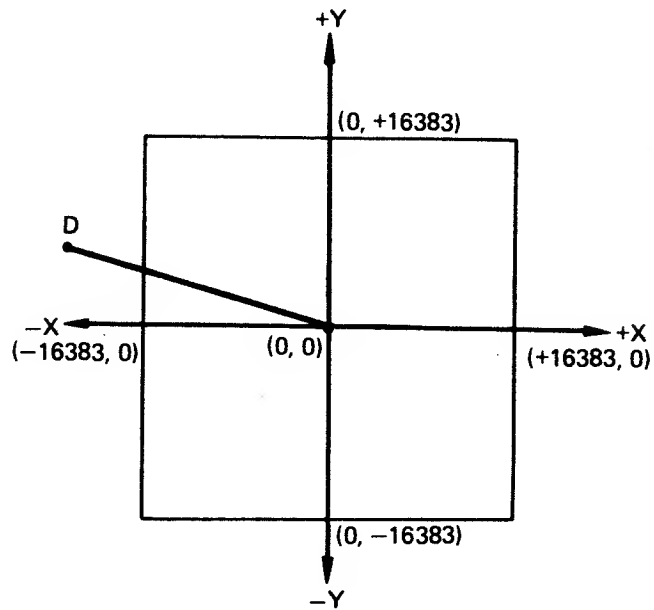

When the origin in the X-direction is not on the left margin part of the absolute coordinate system may be shifted off the useable X-value range.

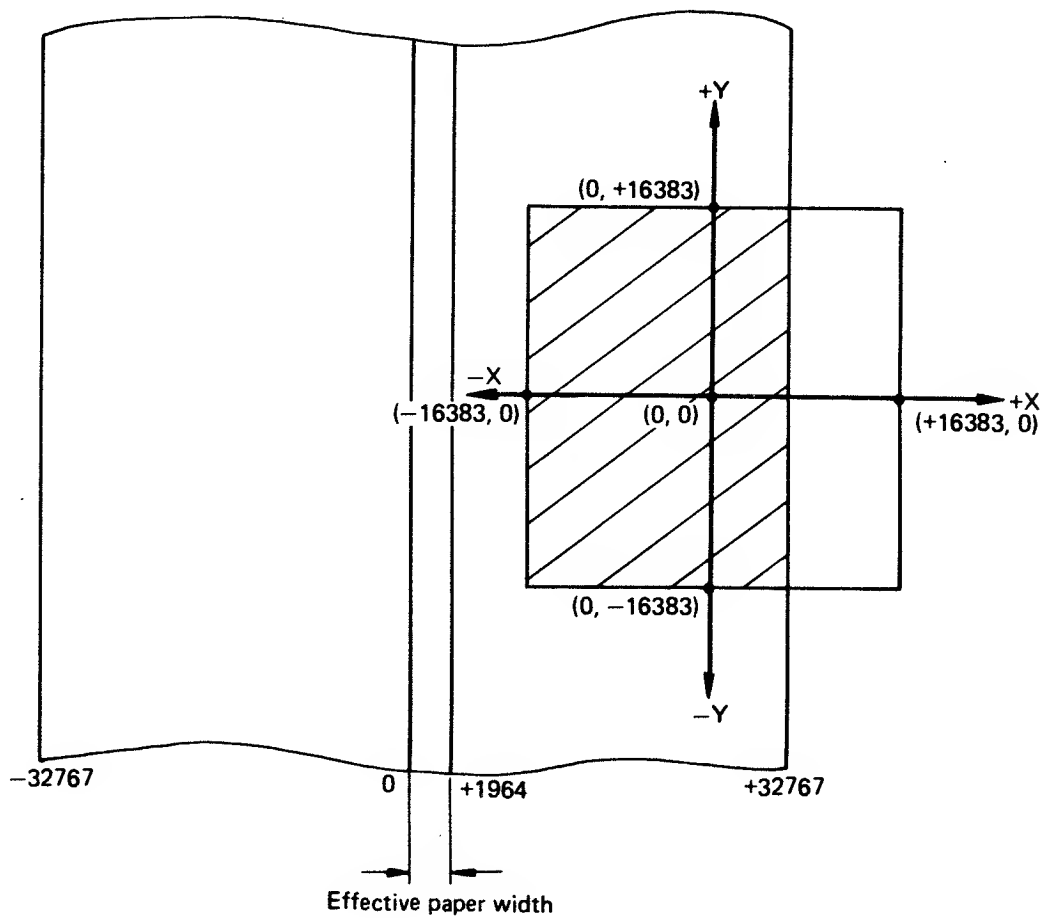

When drawing characters or illustrations, use only the area represented by shading in the above figure. If an attempt is made to draw a character or illustration outside the shaded area, the relationship with the absolute coordinate system will be lost.

Example: When "G01 X12000 Y12000" is input to move the pen from point E to point F, the relationship with the absolute coordinate system will be lost.

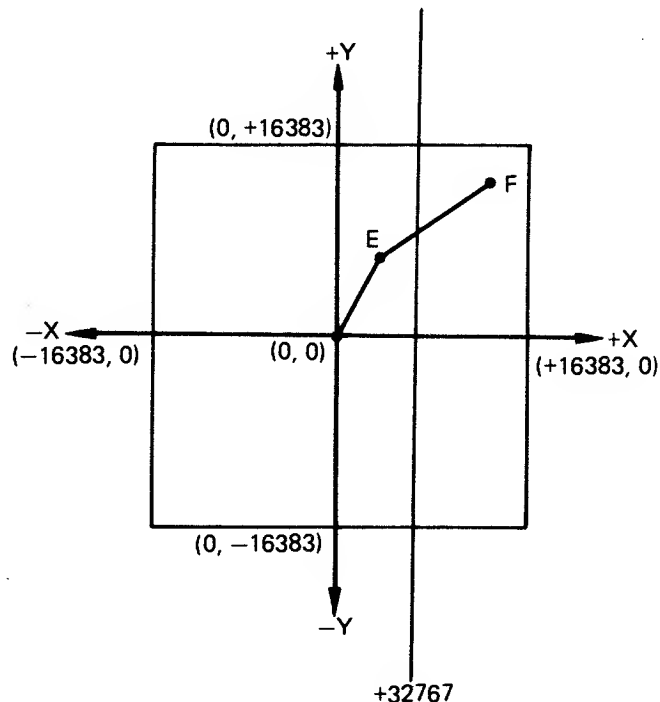

Some Functional Examples

Since the incremental steps are extremely small (0.09525 mm), you can draw "curves" with the Plotter Printer. (Actually these "curves" are made up of a series of very short straight lines.)

This sample program will draw a Sine Curve. First we draw the coordinate axes. Then the sine value is multiplied by 300 in the Y-axis direction to establish the amplitude of the sine wave and this figure is printed on the previously drawn axes.

10 LPRINT CHR\$(2):	'TO BE SURE WE'RE IN P MODE
20 LPRINT "G50 X9000 Y-7300":	'MOVE PEN TO ABOUT CENTER OF PRINTING AREA
30 LPRINT "G03 X0 Y0":	'SET THIS POINT TO NEW ORIGIN
40 LPRINT "G50 X-7000":	'MOVE PEN TO START OF X AXIS
50 LPRINT "G01 X7000":	'DRAWING X AXIS
60 LPRINT "G50 X0 Y-7000":	'MOVE PEN TO START OF Y AXIS
70 LPRINT "G01 Y7000":	'DRAWING Y AXIS
80 LPRINT "G50 X-7000 Y0":	'MOVE PEN TO START OF SINE CURVE
90 FOR X=-7000 TO 7000 STEP 20	
100 Y=SIN(X/111.4)*3000:	'CALCULATE SIN X AND MULTIPLY BY 3000
110 LPRINT "G01 X"; INT(X); "Y"; INT(Y):	'DRAWS ONE STEP OF SINE CURVE
120 NEXT:	'NEXT X VALUE

PLOT OF SINE CURVE

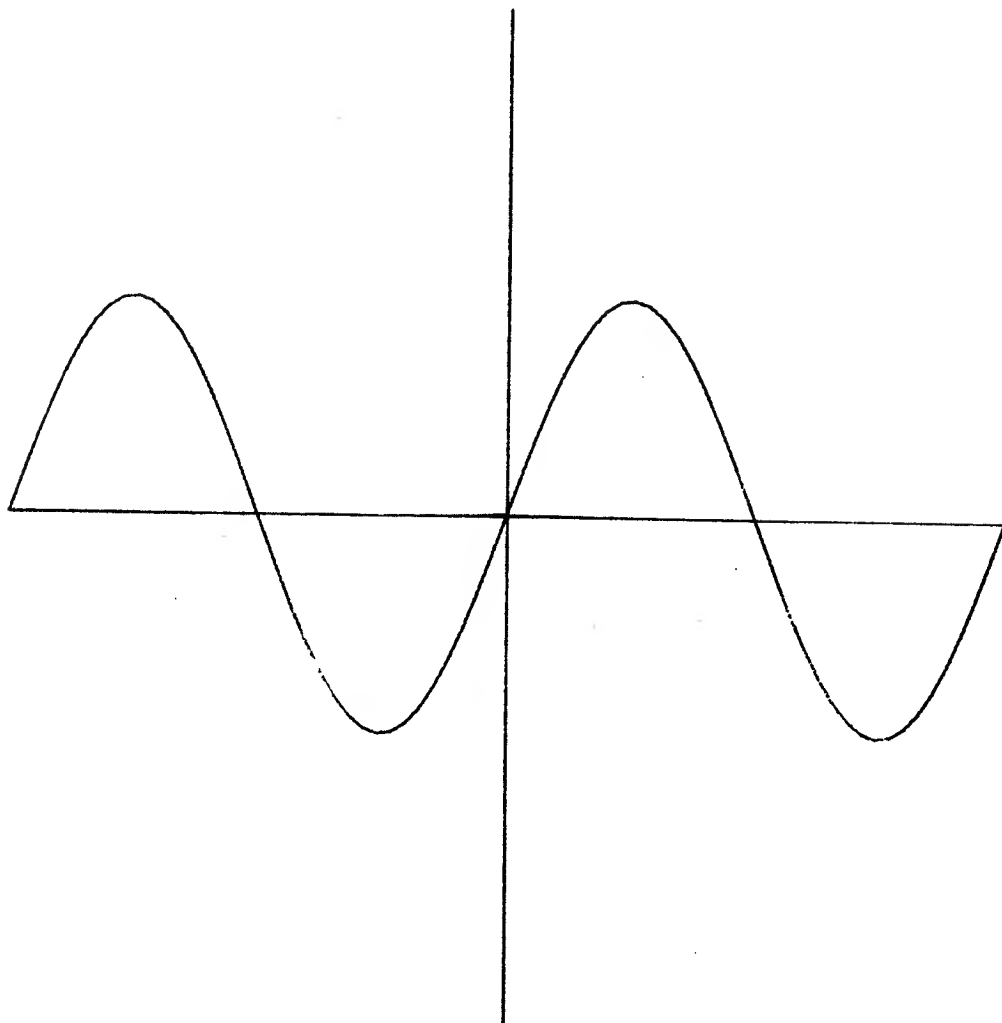

The following is a listing of a much more complex program. It will demonstrate most of the capabilities of the Plotter Printer. We suggest you take a little time to study the program along with the resulting output. It should help you understand some of the features and the required programming techniques.

```

10    REM SAMPLE PROGRAM
20    DEFINT A-Z:LPRINT CHR$(1)CHR$(6)CHR$(17)
30    LPRING CHR$(2)
40    LPRINT"G50 U300 V50
50    LPRINT"G02 X0 Y0
60    REM                                DRAWING "RADIO"
70    LPRINT"G01    X0    Y180
80    LPRINT"G01    X90    Y180
90    LPRINT"G02    X105   Y85    I10    J50
100   LPRINT"G01    X140   Y0
110   LPRINT"G01    X80    Y0
120   LPRINT"G01    X60    Y35
130   LPRINT"G03    X50    Y35    I5     J3
140   LPRINT"G01    X50    Y0
150   LPRINT"G01    X0     Y0
160   LPRINT"G50    X39    Y85
170   LPRINT"G02    I-22   J0
180   LPRINT"G50    X150   Y95
190   LPRINT"G01    X150   Y140
200   LPRINT"G01    X230   Y140
210   LPRINT"G02    X265   Y105   I0     J35
220   LPRINT"G01    X265   Y0
230   LPRINT"G01    X175   Y0
240   LPRINT"G02    X180   Y85    I-10   J-42
250   LPRINT"G01    X195   Y85
260   LPRINT"G03    X195   Y95    I0     J-5
270   LPRINT"G01    X150   Y95
280   LPRINT"G50    X172   Y50
290   LPRINT"G02    I-22   J0
300   LPRINT"G50    X340   Y0
310   LPRINT"G02    X340   Y140   I-4    J-70
320   LPRINT"G01    X360   Y140
330   LPRINT"G01    X360   Y180
340   LPRINT"G01    X415   Y180
350   LPRINT"G01    X415   Y0
360   LPRINT"G01    X340   Y0
370   LPRINT"G50    X346   Y27
380   LPRINT"G02    I0     J-22

```

390	LPRINT"G50	X430	Y0		
400	LPRINT"G01	X430	Y140		
410	LPRINT"G01	X490	Y140		
420	LPRINT"G01	X490	Y0		
430	LPRINT"G01	X430	Y0		
440	LPRINT"G50	X570	Y0		
450	LPRINT"G02	I0	J-75		
460	LPRINT"G50	X570	Y33		
470	LPRINT"G02	I0	J-22		
480	REM				DRAWING 'SHACK'
490	LPRINT"G50	X685	Y0		
500	LPRINT"G01	X685	Y50		
510	LPRINT"G01	X698	Y50		
520	LPRINT"G03	X718	Y70	I0	J-20
530	LPRINT"G01	X720	Y125		
540	LPRINT"G02	X770	Y175	I-50	J0
550	LPRINT"G01	X805	Y175		
560	LPRINT"G01	X805	Y120		
570	LPRINT"G01	X790	Y120		
580	LPRINT"G03	X772	Y102	I0	J20
590	LPRINT"G01	X770	Y50		
600	LPRINT"G02	X720	Y0	I50	J0
610	LPRINT"G01	X685	Y0		
620	LPRINT"G50	X812	Y0		
630	LPRINT"G01	X812	Y175		
640	LPRINT"G01	X865	Y175		
650	LPRINT"G01	X865	Y140		
660	LPRINT"G01	X885	Y140		
670	LPRINT"G02	X935	Y90	I0	J50
680	LPRINT"G01	X935	Y0		
690	LPRINT"G01	X880	Y0		
700	LPRINT"G01	X880	Y85		
710	LPRINT"G03	X866	Y85	I7	J0
720	LPRINT"G01	X866	Y0		
730	LPRINT"G01	X812	Y0		
740	LPRINT"G50	X955	Y95		
750	LPRINT"G01	X955	Y140		
760	LPRINT"G01	X1035	Y140		
770	LPRINT"G02	X1070	Y105	I0	J35
780	LPRINT"G01	X1070	Y0		
790	LPRINT"G01	X980	Y0		
800	LPRINT"G02	X985	Y85	I-10	J-42
810	LPRINT"G01	X1000	Y85		

820	LPRINT"G03	X1000	Y95	10	J-5
830	LPRINT"G01	X955	Y95		
840	LPRINT"G50	X977	Y50		
850	LPRINT"G02	I-22	J0		
860	LPRINT"G50	X1210	Y45		
870	LPRINT"G02	X1215	Y60	163	J-27
880	LPRINT"G01	X1165	Y60		
890	LPRINT"G03	X1165	Y45	120	J7
900	LPRINT"G01	X1210	Y45		
910	LPRINT"G50	X1223	Y0		
920	LPRINT"G01	X1223	Y170		
930	LPRINT"G01	X1263	Y170		
940	LPRINT"G01	X1263	Y95		
950	LPRINT"G03	X1271	Y97	I-3	J0
960	LPRINT"G01	X1290	Y120		
970	LPRINT"G01	X1340	Y120		
980	LPRINT"G01	X1315	Y80		
990	LPRINT"G01	X1340	Y0		
1000	LPRINT"G01	X1285	Y0		
1010	LPRINT"G01	X1275	Y42		
1020	LPRINT"G03	X1263	Y42	16	J0
1030	LPRINT"G01	X1263	Y0		
1040	LPRINT"G01	X1223	Y0		
1050	LPRINT"G50	X120	Y-300		
1060	LPRINT CHR\$(1)CHR\$(5)"TRS-80"CHR\$(3):LPRINT				
1070	LPRINT CHR\$(4)"			PLOTTER/PRINTER"CHR\$(6):LPRINT:LPRINT	
1080	LPRINT CHR\$(3)"			WRITING WITH BALL-POINT PEN	
1090	LPRINT CHR\$(6)"			YOU CAN PRINT	
ALPHANUMERIC CHARACTERS					
1100	LPRINT				
1105	LPRINT"			AT FOUR ANGLES OF ROTATION	
1106	LPRINT				
1107	LPRINT"			YOU CAN ALSO PLOT	
1108	LPRINT				
1110	LPRINT"			'STRAIGHT LINES', 'DOTTED LINES'	
AND 'CURVES'					
1120	LPRINT				
1130	REM			DRAWING COORDINATE SYSTEM	
1140	LPRINT CHR\$(2)				
1150	LPRINT"G50	X650	Y-730		
1160	LPRINT"G02	X0	Y0		
1170	LPRINT"G50	X-700			
1180	LPRINT"G01	X700			

```

1190 LPRINT"G50 X0 Y-700
1200 LPRINT"G01 Y700
1210 REM DRAW HYPERBOLA
1220 LPRINT"G50 X-690 Y-30
1230 FOR X=-690 TO 690 STEP 20
1240 Y=21000/X:IF X<19 AND X>-19 THEN 1270
1250 IF X=30 THEN LPRINT"G50 X"X"Y"Y
1260 LPRINT"G01 X"X"Y"Y
1270 NEXT
1280 REM DRAW PARABOLA
1290 LPRINT"G50 X-500 Y700
1300 FOR X=-500 TO 500 STEP 10
1310 Y=X*X/357
1320 LPRINT"G01 X"X"Y"Y
1330 NEXT
1340 REM DRAW CIRCLE
1350 LPRINT"G50 X500 Y0
1360 LPRINT"G02 I500
1370 REM DRAW SINE
1380 LPRINT"G50X-700
1390 FOR X=-700 TO 700 STEP 20
1400 Y=SIN(X/111.4)*300:LPRINT"G01 X"X"Y"Y
1410 NEXT
1420 REM DRAW DOTTED LINE
1430 LPRINT"G50 X-700 Y-700
1440 LPRINT"G00 X700 Y700
1450 REM ROTATE CHARACTERS
1460 LPRINT"G50 X750 Y190
1470 LPRINT CHR$(1)CHR$(18)"PLOTTER/PRINTER";
1480 LPRINT CHR$(2)
1490 LPRINT"G50 U-570 V-570
1500 LPRINT CHR$(1)CHR$(19)"PLOTTER/PRINTER";
1510 LPRINT CHR$(2)
1520 LPRINT"G50 U-570 V570
1530 LPRINT CHR$(1)CHR$(20)"PLOTTER/PRINTER";
1540 LPRINT CHR$(2)
1550 LPRINT"G50 U100 V140
1560 LPRINT CHR$(1)CHR$(17)"Y=SIN(X)";
1570 LPRINT CHR$(2)
1580 LPRINT"50 U20 V300

```



```
1590 LPRINT CHR$(1)"Y=X";
1600 LPRINT CHR$(2)
1610 LPRINT"G50 V20
1620 LPRINT CHR$(1)"2";
1630 LPRINT CHR$(2)
1640 LPRINT"G50 U430 V-20
1650 LPRINT CHR$(1)"Y=1/X";
1660 LPRINT CHR$(2)
1670 LPRINT"G50 U320 V-150
1680 LPRINT CHR$(1)"Y=X";
1690 LPRINT CHR$(2)
1700 LPRINT"G50 U-420 V-1000
1710 LPRINT CHR$(1)"X=SIN(T), Y=COS(T)";
1720 LPRINT STRINGS (25, 10)
1730 END
```

ASCII Code Table

Decimal	Hex	Function	Decimal	Hex	Character
0	0		21	15	
1	1	C. MODE	22	16	
2	2	P. MODE	23	17	
3	3	2 MUL	24	18	
4	4	4 MUL	25	19	
5	5	8 MUL	26	1A	
6	6	1 MUL	27	1B	
7	7		28	1C	
8	8	BS	29	1D	
9	9		30	1E	
10	A	LF	31	1F	
11	B		32	20	SP
12	C		33	21	!
13	D	CR.LF	34	22	"
14	E		35	23	#
15	F		36	24	\$
16	10		37	25	
17	11	Rotate 0	38	26	&
18	12	Rotate 90	39	27	'
19	13	Rotate 180	40	28	(
20	14	Rotate 270	41	29)

Decimal	Hex	Character	Decimal	Hex	Character
42	2A	*	63	3F	?
43	2B	+	64	40	@
44	2C	'	65	41	A
45	2D	-	66	42	B
46	2E	.	67	43	C
47	2F	/	68	44	D
48	30	0	69	45	E
49	31	1	70	46	F
50	32	2	71	47	G
51	33	3	72	48	H
52	34	4	73	49	I
53	35	5	74	4A	J
54	36	6	75	4B	K
55	37	7	76	4C	L
56	38	8	77	4D	M
57	39	9	78	4E	N
58	3A	:	79	4F	O
59	3B	;	80	50	P
60	3C	<	81	51	Q
61	3D	=	82	52	R
62	3E	>	83	53	S

Decimal	Hex	Character	Decimal	Hex	Character
84	54	T	104	67	H
85	55	U	105	68	I
86	56	V	106	69	J
87	57	W	107	6A	K
88	58	X	108	6B	L
89	59	Y	109	6D	M
90	5A	Z	110	6E	N
91	5B		111	6F	O
92	5C		112	70	P
93	5D		113	71	Q
94	5E		114	72	R
95	5F		115	73	S
96	60		116	74	T
97	61	A	117	75	U
98	62	B	118	76	V
99	63	C	119	77	W
100	63	D	120	78	X
101	64	E	121	79	Y
102	65	F	122	7A	Z
103	66	G			

C. MODE : Sets to character mode

P. MODE : Sets to plotter mode

1 MUL : Base size characters (C)

2 MUL : Twice base size (C)

4 MUL : Four times base size (C)

8 MUL : Eight times base size (C)

CR. LF : Carriage return line feed code (C)

0 : 0 degree code (C)

90 : 90 degree code (C)

180 : 180 degree code (C)

270 : 270 degree code (C)

BS : Back space code (C)

LF : Line feed code (C)

SPECIAL NOTES

Replacement of the ball-point pen.

When the pen runs dry, open the front cover and carefully remove the pen without moving the head position. Replacement black pens can be obtained through your local Radio Shack store or Computer Center. Also many stationery supply stores will have suitable replacements; use Fisher Pen type PR4M (medium reproduceable black). We recommend the use of medium point pens because some Fisher fine point pens do not fit properly in the Plotter Printer.

Other colors are available (Fisher Pen type PR-4). If not available locally, contact:

FISHER PEN CO
Customer Service
743 Circle Avenue
Chicago, Illinois 60630
Phone # 800-323-3918

PRECAUTIONS

- * When the POWER switch is ON, be sure the pilot lamp is lit.
- * Be sure the connectors are firmly attached.
- * Be sure the cover is fully closed.
- * Do not operate the Plotter Printer in locations where it will be exposed to direct sunlight, excessive dust or dirt, excessive moisture, or heat sources (such as radiators, hot air vents, etc.).
- * Always position the Plotter Printer on a firm, level surface.
- * Be sure to start printing with a continuous line (not dots) to get the ink flowing.
- * Do not print too many dots consecutively or the pen will dry out. (The ballpoint needs to roll.)

Connector Connection Diagram

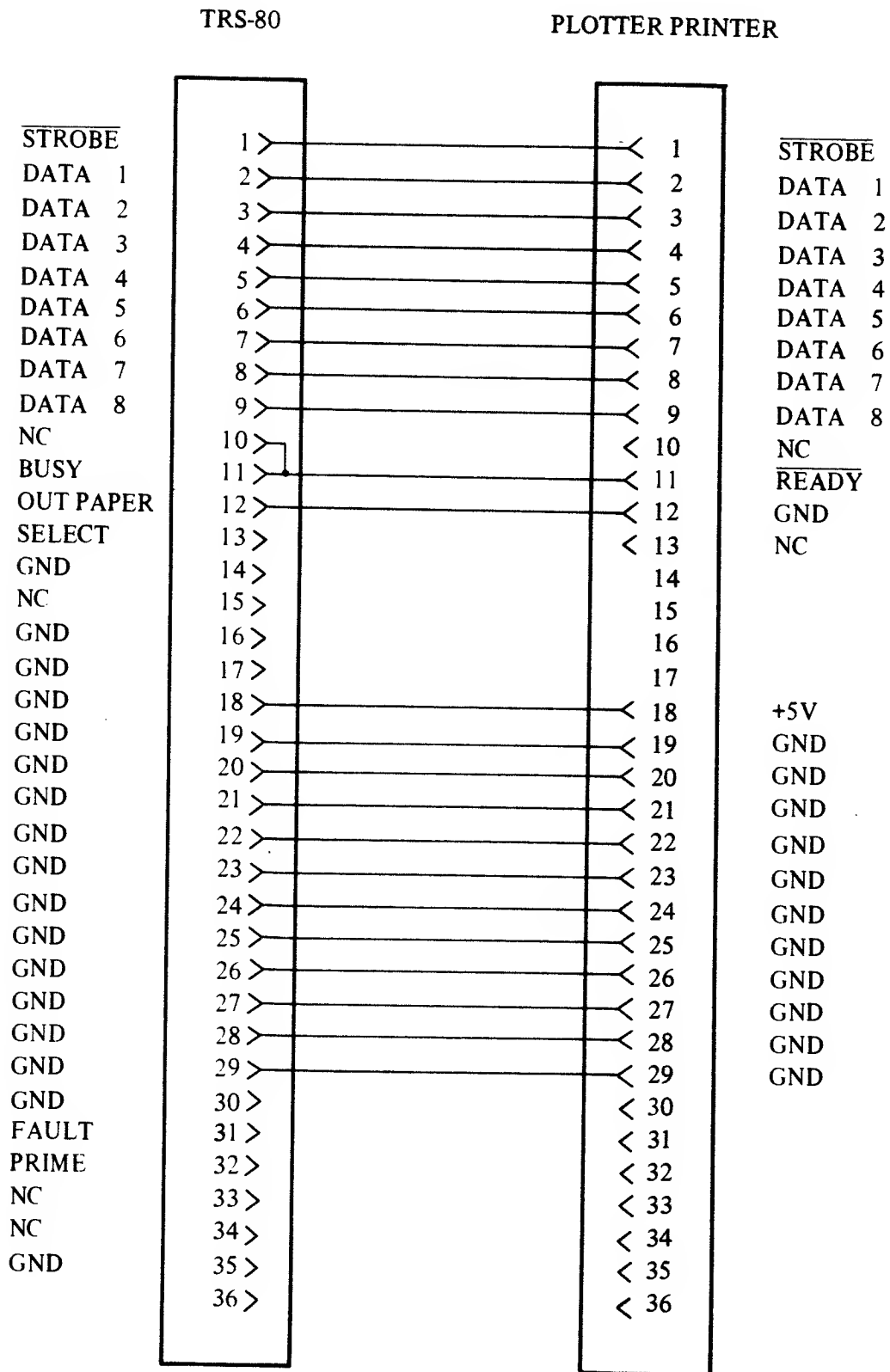

Interface Timing

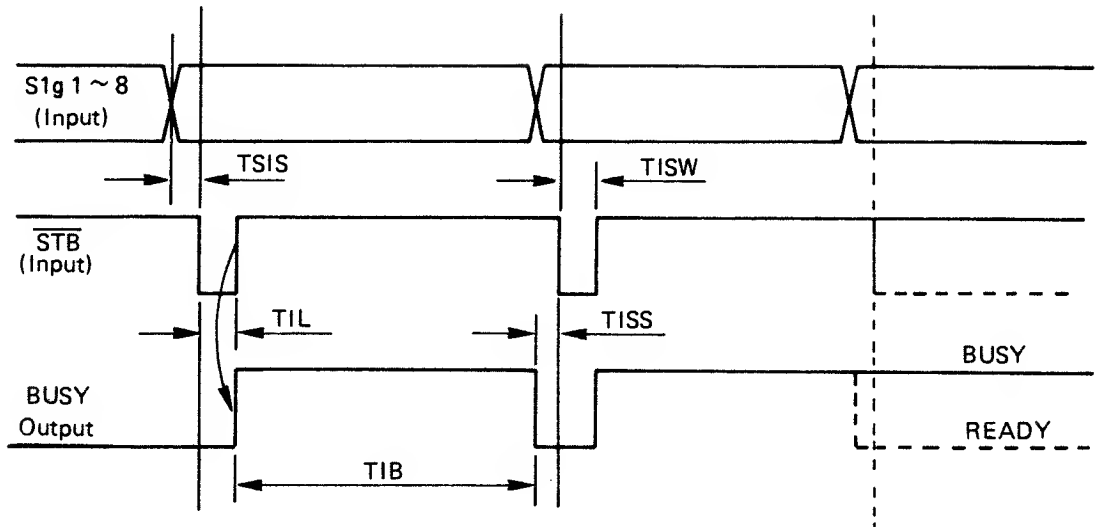

- Note:**
1. Input signal level [H] 2V to 5.25V
[L] 0V to 0.8V
 2. When STB is in [L] level continuously, it will not become READY.

SYM	PARAMETER	MIN	MAX
TSIS	Signal Input set TIME	0.2 μ S	—
TIL	Input Load TIME	1.0 μ S	60 μ S
TIB	Input Busy TIME	110 μ S	—
TISS	Input Strobe Set TIME	0 μ S	—
TISW	Input Strobe Pulse Width TIME	2.0 μ S	—

Radio Shack[®]

TRS-80

PLOTTER/PRINTER

WRITING WITH BALL-POINT PEN

YOU CAN PRINT ALPHANUMERIC CHARACTERS

AT FOUR ANGLES OF ROTATION

YOU CAN ALSO PLOT

'STRAIGHT LINES' , 'DOTTED LINES' AND 'CURVES'.

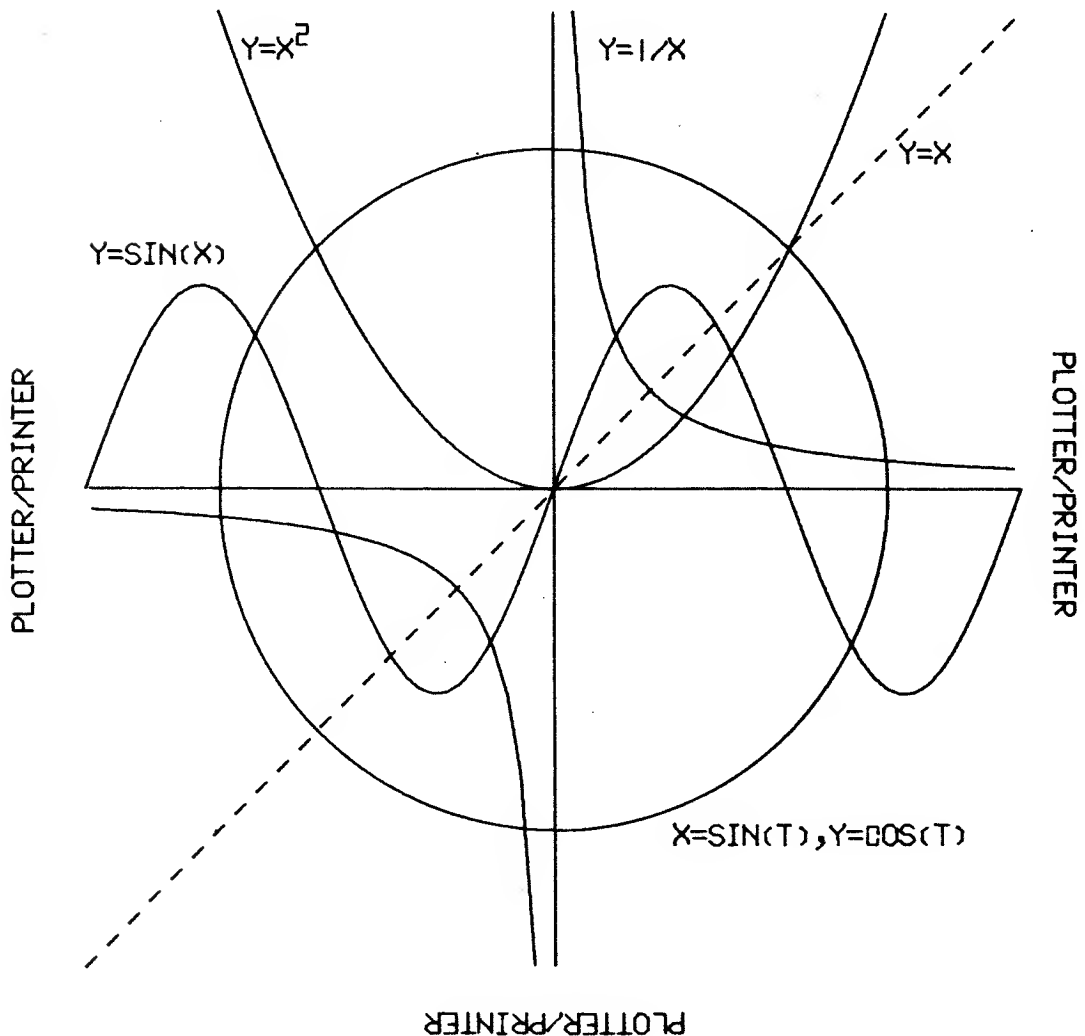

SPECIFICATIONS

Printing System:	Ball-point pen
Printing Speed:	Average 10 characters/sec (base size characters)
Step-by-step Speed:	667 steps/second
Step Dimensions:	0.09525 mm for both X and Y axes = $3/800$ " <i>inches/step</i>
Control codes:	Standard ASCII Code (characters & symbols) plus special control codes
Characters-per-line:	80 maximum with auto wraparound
Character Spacing:	2.3 mm (24 steps)
Line-feed Spacing:	4.2 mm (44 steps)
Paper Size:	9" (8-1/2" sprocket width) 7-3/8" effective width for writing (75 characters) (Catalog number 26-1407)
Life of ball-point pen:	Approx 500,000 characters (4500 meters) (Ball-point pen: Radio shack part number ACT-0165)
Power Requirements:	120 Volts, 60 Hz (220/240 VAC on European/Australian models) 120 VA (max inrush current = 25 A for 5mS or less)
Noise Level:	70 dB at 1 meter
Dimensions:	6.4 x 15.9 x 12.3 in (H x W x D) (162 x 405 x 313 mm)
Weight:	15 lbs (7 kg) without paper
Ambient Temperature:	Operation: 41 to 104°F (5 to 40°C) Storage: 14 to 122°F (-10 to 50°C) Operation: 40 to 80% Storage: 20 to 90% (non-condensing)
Recording Accuracy:	*Relative accuracy: 0.15% or less Repeatability: 0.1 mm or less

* Relative accuracy is defined as follows:

$$\frac{(\text{Theoretical Distance}) - (\text{Actual Distance})}{\text{Theoretical Distance}} \times 100 =$$

(Distance refers to the distance that the pen travels/should travel)

Paper rewinding length allowable : 0.5 m

Warning: This equipment generates, uses, and can radiate radio frequency energy and if not installed and used in accordance with the instructions manual, may cause interference to radio communications. It has been tested and found to comply with the limits for a Class A computing device pursuant to Subpart J of Part 15 of FCC Rules, which are designed to provide reasonable protection against such interference when operated in a commercial environment. Operation of this equipment in a residential area is likely to cause interference in which case the user at his own expense will be required to take whatever measures may be required to correct the interference.

SERVICE POLICY

Radio Shack's nationwide network of service facilities provides quick, convenient, and reliable repair services for all of its computer products, in most instances. Warranty service will be performed in accordance with Radio Shack's Limited Warranty. Non-warranty service will be provided at reasonable parts and labor costs.

Because of the sensitivity of computer equipment, and the problems which can result from improper servicing, the following limitations also apply to the services offered by Radio Shack:

1. If any of the warranty seals on any Radio Shack computer products are broken, Radio Shack reserves the right to refuse to service the equipment or to void any remaining warranty on the equipment.
2. If any Radio Shack computer equipment has been modified so that it is not within manufacturer's specifications, including, but not limited to, the installation of any non-Radio Shack parts, components, or replacement boards, then Radio Shack reserves the right to refuse to service the equipment, void any remaining warranty, remove and replace any non-Radio Shack part found in the equipment, and perform whatever modifications are necessary to return the equipment to original factory manufacturer's specifications.
3. The cost for the labor and parts required to return the Radio Shack computer equipment to original manufacturer's specifications will be charged to the customer in addition to the normal repair charge.

LIMITED WARRANTY

For a period of 90 days from the date of delivery, Radio Shack warrants to the original purchaser that the computer hardware unit shall be free from manufacturing defects. This warranty is only applicable to the original purchaser who purchased the unit from Radio Shack company-owned retail outlets or duly authorized Radio Shack franchisees and dealers. This warranty is voided if the unit is sold or transferred by purchaser to a third party. This warranty shall be void if this unit's case or cabinet is opened, if the unit has been subjected to improper or abnormal use, or if the unit is altered or modified. If a defect occurs during the warranty period, the unit must be returned to a Radio Shack store, franchisee, or dealer for repair, along with the sales ticket or lease agreement. Purchaser's sole and exclusive remedy in the event of defect is limited to the correction of the defect by adjustment, repair, replacement, or complete refund at Radio Shack's election and sole expense. Radio Shack shall have no obligation to replace or repair expendable items.

Any statements made by Radio Shack and its employees, including but not limited to, statements regarding capacity, suitability for use, or performance of the unit shall *not* be deemed a warranty or representation by Radio Shack for any purpose, nor give rise to any liability or obligation of Radio Shack.

EXCEPT AS SPECIFICALLY PROVIDED IN THIS WARRANTY OR IN THE RADIO SHACK COMPUTER SALES AGREEMENT, THERE ARE NO OTHER WARRANTIES, EXPRESS OR IMPLIED, INCLUDING, BUT NOT LIMITED TO, ANY IMPLIED WARRANTIES OF MERCHANTABILITY OR FITNESS FOR A PARTICULAR PURPOSE. IN NO EVENT SHALL RADIO SHACK BE LIABLE FOR LOSS OF PROFITS OR BENEFITS, INDIRECT, SPECIAL, CONSEQUENTIAL OR OTHER SIMILAR DAMAGES ARISING OUT OF ANY BREACH OF THIS WARRANTY OR OTHERWISE.

7-80

RADIO SHACK  A DIVISION OF TANDY CORPORATION

U.S.A.: FORT WORTH, TEXAS 76102
CANADA: BARRIE, ONTARIO L4M 4W5

TANDY CORPORATION

AUSTRALIA

280-316 VICTORIA ROAD
RYDALMERE, N.S.W. 2116

BELGIUM

PARC INDUSTRIEL DE NANINNE
5140 NANINNE

U. K.

BILSTON ROAD WEDNESBURY
WEST MIDLANDS WS10 7JN