



# build an

By Jorma Hyypia

**T**HE SNOOPERSCOPE and its first cousin, the sniperscope, were designed originally for military use to enable infantrymen to secretly observe the enemy and to aim rifles accurately in total darkness. But these same devices have countless peacetime applications having nothing whatever to do with guerilla warfare. Some of the diverse practical applications of the snooperscope are discussed at the end of this article.

If you can part with \$325, by all means buy a ready-to-use surplus sniperscope (Edmund Scientific Co., Barrington, N. J.). But if that price is too steep for your budget, consider building a snooperscope at considerable saving, from surplus parts obtainable from the same firm.

**The viewing telescope** consists of four integrated parts: (1) a metal tube containing the infra-red sensitive IP25 image tube, (2) a slightly larger tube in which the first tube slides for the purpose of focusing, (3) a focusable eyepiece, (4) objective lens system.

The IP25 image tube fits into a tube made from a hair spray can 2 in. in diameter and about 5½ in. long. Before puncturing the can, release all pressure through the nozzle. With an awl or nail, punch a series of closely spaced holes along the edge of the depression or well surrounding the nozzle; push out this perforated flat disc, containing the nozzle, and smooth the rough edges inside the well.

Solder a piece of brass tubing, 1 in. in diameter and ½ in. long, to the opening thus formed. This will contain the sliding eye-piece assembly.

Use a rotary can opener to remove the bottom of the can. Cut a ⅝ in. diameter hole in the side of the can, just below the upper rim, to take a ⅝ in. I.D. rubber grommet. The power cable leading to the image tube will pass through this hole.

Form a five-lead power cable by bundling 7-ft. lengths of wire together inside a large diameter spaghetti, a rubber tube, or by wrapping plastic electrical tape along the length of the wires. *Make certain that the wire you use for this cable is of the type whose insulation can withstand at least 5000 volts potential.* Most of the wires will carry several hundred, and one carries 4250 volts!

Mark all wires carefully at each end so that you will know later to what tube pin each wire is attached. Push one end of the cable through the rubber grommet and pull it out through the large end of the can. On the end of each wire solder a lug obtained by breaking apart an octal miniature radio tube socket; these lugs will help slip neatly onto the IP25 tube pins. Attach the wires to pins 1, 4, 5, 6 and 7 (see Fig. B for identification of these pins). The remaining pins on the tube are not used. Wrap a turn or two of electrical tape around the pins.

# infra-red SNOOPERSCOPE

Save \$250 or more by using surplus parts for this multi-purpose item

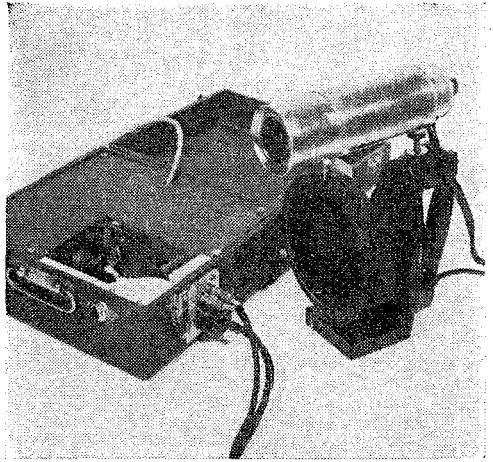

COMPLETE infra red lamp, telescope and power pack. Note plugs on side of case.

Now wrap a piece of felt all the way around the tube so that its full length is covered. The type of felt used as a pad under floor carpets serves very well, and can be pulled apart to make it thinner if necessary. The padded tube should fit very snugly inside the can. The pad not only keeps the tube aligned properly and acts as a shock absorber, but also serves to insulate the tube pins from the metal can. See that the tube is pushed all the way into the can, so that the small end of the tube is as close as possible to the neck of the can.

The second can is made from a beer can  $4\frac{3}{4}$  in. long and  $2\frac{1}{2}$  in. in diameter. Remove the punctured top of the can with a rotary can opener to get a smooth edge. Do not use the can opener to remove the other end, which should have a slightly smaller hole (approx.  $2\frac{1}{8}$  in. diam.) cut into it. The  $\frac{3}{16}$  in. wide rim thus formed keeps the felt packing inside this larger can from working out.

This second layer of felt keeps the image tube can properly centered in the larger can while permitting it to slide smoothly back and forth for purposes of focusing. The felt liner should be cut short enough to allow the inner can to slide for a distance of about  $1\frac{1}{2}$  in. To install, line the inside of the larger can with the felt and use pieces of gummed tape to hold it close to the smaller end of the can. Slowly force the smaller can past

the felt until it is in position. Check to see that your felt thickness is sufficient to prevent the image can from wobbling.

Before installing the image can inside the larger one, rivet the rear mounting bracket near the rear end of the larger can.

Fashion a metal sleeve, at least  $\frac{3}{4}$  in. wide, that will telescope snugly into the open end of the larger can. Fasten in place with three self-tapping sheet metal screws, leaving half of the ring protruding from the can; the objective lens assembly will fit onto the projecting part of the sleeve.

The lid from a typewriter ribbon can ( $2\frac{1}{2}$  in. diam. and  $\frac{3}{4}$  in. deep) provides a good sleeve. Cut a  $1\frac{3}{4}$  in. diameter hole in the top of the lid; this leaves a narrow rim that helps strengthen the sleeve.

The two lower screws holding the sleeve also serve to fasten a  $\frac{1}{2}$ -in. wide strip of sheet metal along the outside of the can; this strip has a small tab bent into it at the mid-point. A hole in the tab engages the bolt that fastens the front end of the telescope to a bracket mounted on the top of the infra red light unit.

**Objective.** Another  $2\frac{1}{2}$ -in. diam. can is used to house the objective lenses. Cut this can down to a length of  $2\frac{1}{4}$  in. and make a  $1\frac{3}{4}$  in. diam. hole in the bottom. The lip thus formed serves to hold the lenses inside the can. Fit a black cardboard washer inside

this lip before inserting the first lens, so that the metal won't scratch the lens.

Two achromatic lenses with 52 mm diameters and 193 mm focal lengths (Edmund No. 5216, coated; or No. 5117, uncoated) comprise an efficient optical system.

Note carefully the orientation of the lenses in Fig. A. The greatest curvature of each lens should be forward. Some sort of centering ring is required around the edge of each lens to keep it centered in the can. A ring made from  $\frac{3}{8}$ -in. diameter rubber tubing is easy to install and works well; it compresses to form a good, shock-resisting support.

The black cardboard spacer between the two lenses should be just thick enough to keep the surfaces from each other.

Place another cardboard washer behind the second lens, and hold the entire assembly firmly in place with a retainer ring. A piece of  $\frac{1}{4}$ -in. diam. electrical cable, used in heavy duty house wiring, forms an ideal ring; it has just enough springiness and the rubber insulation prevents marring of the lens. The exposed portions inside the can should be painted a flat black to minimize reflections.

The eyepiece is made from two achromat lenses, each 18 mm in diameter with a focal length of 38 mm. Mount these inside a metal or plastic tube that will slide smoothly into the brass tube soldered on the back end of the image tube can.

A plastic bottle cap  $\frac{3}{4}$  to 1 in. long serves well; cut most of the top end out, leaving a  $\frac{1}{8}$ -in. rim to retain the lenses in the barrel thus formed. The lenses are carefully aligned in the tube, using short pieces of electrical wire to form the spacers and retaining ring. Before inserting the lenses in the cap, cut a diagonal slot on the side; the tip of a short

bolt threaded into a hole on the side of the brass tube fits into this slot. When the lens unit is rotated, the bolt forces the unit to move back and forth smoothly. The front of the eyepiece unit will have to rack very close to the end of the image tube.

**Handle assembly.** The telescope and infra red light source should be mounted on some sort of handle; this can be an old gunstock, a simple grip fashioned from wood or plastic, or the very efficient handle improvised from a discarded steam iron.

The steam iron handle assembly, as described here, has several unique advantages. The plastic handle is designed for a comfortable grip; the hollow body of the handle conceals the infra red lamp wiring; the various holes in the handle are conveniently located for installation of a switch and a telescope mounting bolt and provide a place through which to lead the lamp cable. Moreover, the wooden lamp bracket attached to the handle has a flat bottom which permits the lamp to be set upright on any flat surface for more comfortable, prolonged viewing.

Remove the handle from the iron, saving the three bolts that hold it in place—these can be used to fasten the handle to the  $\frac{1}{2}$ -in. thick plywood panel shaped to fit the handle. Two blocks of wood are screwed to the bottom of the panel to hold the infra red lamp which can be attached with three screws.

Run a two-lead wire from the lamp, through the panel, into the base of the steam iron handle. A removable plate at this point provides a convenient place to make the necessary connections to the wires running to the on-off switch and the power cord. Mount the push type switch into a notch filed over the hole where the steam control button was

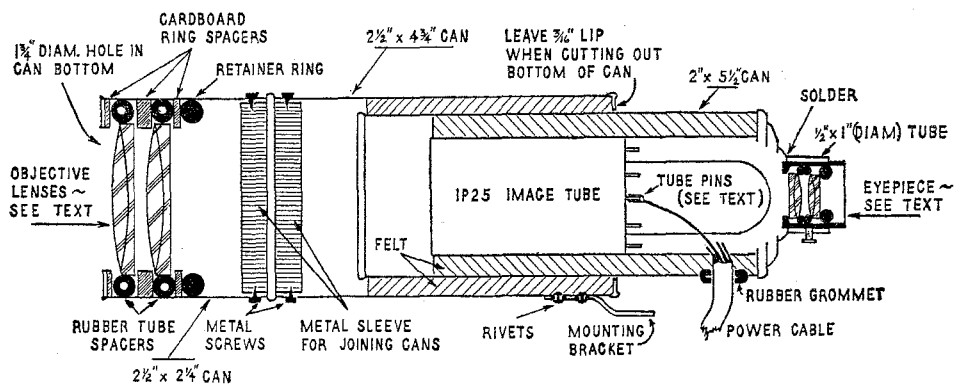

FIG. A: Optics and image tube assembly

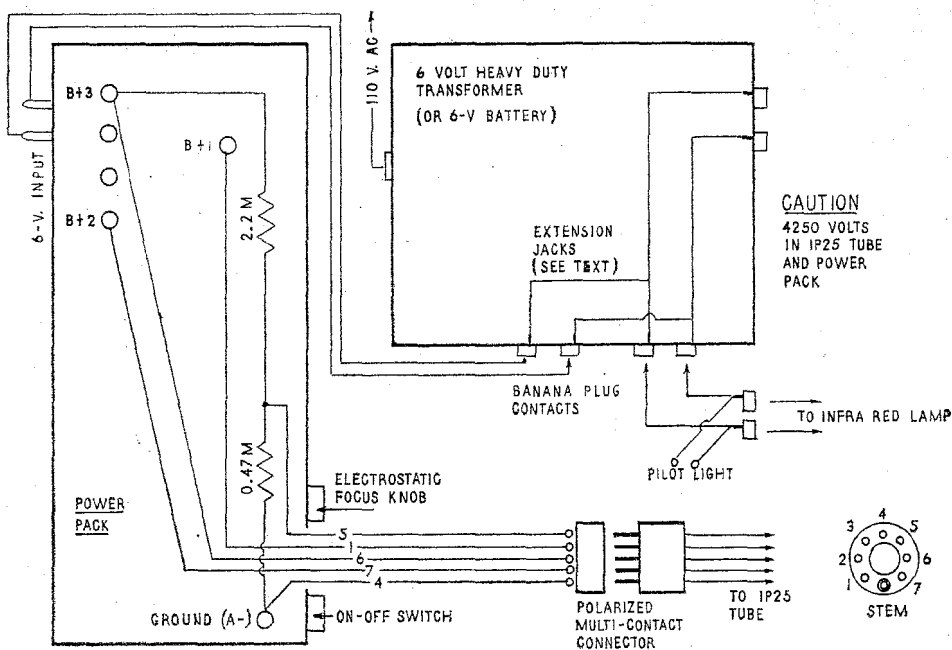
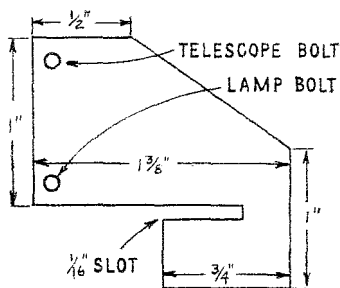
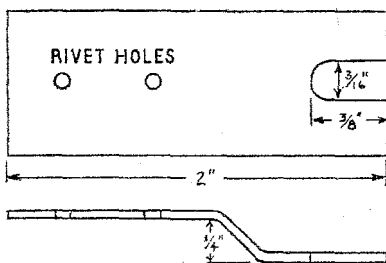

FIG. B: Power supply

# SNOOPERSCOPE



FRONT BRACKET



REAR BRACKET

FIG. C: Telescope mounts

originally located; fasten with epoxy cement.

The power cord comes out of the bottom of the handle, through the same hole where the steam iron cord originally emerged.

The bolt, fitted into the hole originally used to add water to the steam iron, can be screwed up and down in order to tilt the telescope it helps support. This tilting feature is very convenient when viewing objects at close range because it compensates for the parallax which would otherwise cause the telescope to miss the most intense area of infra red light beamed by the lamp. Parallax is no problem for viewing distant objects.

To assemble the bolt unit, cut a flat strip of rigid sheet metal to slip inside of the handle, just under the hole. Drill a hole in the strip, making it slightly larger than the bolt (a piece of 1/4-in. diam. threaded rod about 2 in. long). Find an iron washer that fits into the cuplike depression on the outer side of the water hole.

Solder a nut over the hole in the metal strip. Slip the nut into the hole, positioning the metal strip inside the handle. Place the washer over the nut, clamp in place, and sweat solder the nut and washer together.

A groove is filed into the top end of the bolt. This locks into the slot filed into the end of the rear mounting bracket already attached to the telescope unit. Just below the

# SNOOPERSCOPE

groove, attach a fiber washer that will serve as a thumb nut for adjusting the bolt; this is held in position with two thin nuts made by sawing a regular nut in half.

The front end of the telescope is fastened to a bracket fitted on the top of the infra red lamp; the bolt that holds the filter ring on the lamp can be used to attach the bracket. Use only one bolt to fasten the telescope to the bracket so that this can serve as a pivot point; use two nuts, with a lock washer between them, leaving them just loose enough to let the telescope pivot without wobbling.

A **special power pack** provides all the voltages, up to 4,250 volts, required to make the IP25 tube function. Figure B shows all the necessary connections. The 2.2M and 0.47M resistors are not contained in the original pack but must be added.

The wires are marked according to the IP25 tube pins they must connect. Use the same high-voltage wires in this part of the circuit as for the main power cable.

A source of 6 volts AC or DC is needed to power the power pack. This can be a heavy duty transformer (the unit mentioned in the parts list), a 6-volt car battery, or any other heavy-duty low voltage source. The IP25 tube draws very little current, but the infra red lamp bulbs require 5 amperes at about 6 volts.

The extension banana jacks inside the transformer were installed so that the unit could be more conveniently positioned inside the carrying case. The extra pair of jacks was added so that both the power pack and infra red lamp could be plugged to the trans-

former. The two pairs of jacks are actually stacked one above the other, rather than side by side as shown in the diagram; this leaves more hand room inside the well in the case.

Use one set of transformer jacks to lead a power line to the banana plugs protruding from the power pack. A short extension cord leads to two jacks mounted on a small aluminum panel on the outside of the carrying case; the cable from the infra red light is plugged in here. The same panel also contains the high-voltage socket for the IP25 power line.

Note that a pilot light is used to indicate when the transformer is turned on. The bulb (6 volt, TS-47) is mounted inside the box, under the curved shield, where it serves to illuminate the well and also shine light through a hole behind the ruby glass button. Incidentally, the ruby button fits perfectly into the hardware surrounding the crank hole of the phonograph box used as a case.

**High voltage connector.** Resist the temptation to buy a ready-made multiple plug and socket from your radio supply store unless it is clearly marked for high voltage use; most of the units sold for radio work will arc at these high voltages.

You can easily make a suitable connector from the base of an old radio tube and an octal socket. Remove all but five lugs from the socket, taking out alternate lugs to increase spacing between the remaining ones. Three lugs will remain adjacent to each other; use these for relatively low voltage connections to tube pins 4, 5 and 6. Use the more isolated pins for tube pins 1 and 7.

Cut the socket lugs as short as possible while leaving enough length to permit secure soldering of the wires. It is then a good idea to spray the lugs with liquid insulator (e.g. *Injectoral*) sold at radio supply houses.



THE MULTI-LEAD high voltage connector is made from the base of an old radio tube.

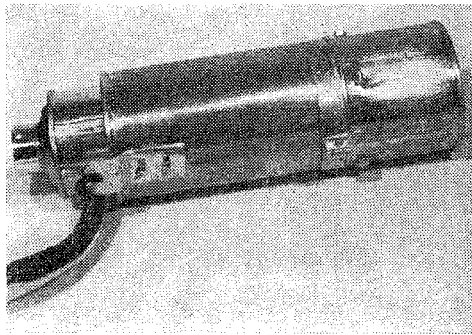

THE UNDERSIDE of the telescope unit showing the front and rear mounting brackets.

To make the plug, break apart an old radio tube, removing all inside components to reveal the open ends of the pins. Heat each pin with a soldering iron so that you can pull out the attached wires. Solder your cable leads to these pins, making certain that they connect with the proper contacts in the socket. Do this soldering job carefully as follows: bare just enough wire to almost reach the bottom of the pin, coat fairly liberally with solder, and insert into the pin. Heat the outside of the pin to melt the solder while pushing the wire inward; this will melt some of the insulation which will flow over the upper end of the pin to insulate it.

Before attaching the wires, remember to slip a cover disc on the cable. This is a washer cut from 1/8-in. thick Bakelite scrap; it is cemented to the top of the plug with suitable plastic-bonding cement.

**Carrying case.** The surplus high-voltage power pack is weather-proof and only requires the attachment of a transformer or other 6-volt power source. But if you want to integrate all components to form a really efficient power unit, assemble all parts into a plywood case as shown. This sturdy case originally contained a child's phonograph. The inside dimensions of the box (3 1/4 x 10 1/4 x 10 1/4 in.) were just right to house the power pack and transformer and still leave a well into which the various connections could be installed. The well also permits adjustment of the power pack on-off switch and its electrostatic focusing knob. The cover section is 2 in. deep, and provides adequate space for storage of the transformer power cord and other extension cords, spare infra red bulbs and other paraphernalia.

Wood blocks hold the power pack and transformer in position, while the 1/8-in. thick hardboard panel, bolted on top, keeps them

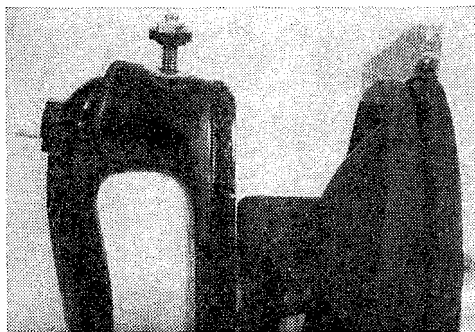

**STEAM IRON handle and lamp.** Bracket on top of lamp supports front of telescope.

## MATERIALS LIST— SNOOPERSCOPE

No. Req.	Size and Description	Approx. Price per unit
1	1P25A infra red image tube	\$ 9.95
1	power pack for 1P25A image tube	15.00
1	115V AC—6V AC transformer	20.00
1	6V infra red light source	10.00
2	achromatic objectives, 52mm x 193mm coated or uncoated	3.50 3.00
2	achromatic lenses, 18mm x 38mm (All above items are obtainable from Edmund Scientific Co., Barrington, N. J.)	2.00
50 ft.	high voltage wire (insulation rated at least 5,000 volts)	1.70
6	banana plugs	1.08
6	banana plug jacks	1.08
1	Pilot light and TS-47 bulb	0.55
1	pushbutton switch	0.70
1	octal tube socket	0.15
10 ft.	two-conductor, wire for infra red lamp misc. hardware including old steam iron handle, hair spray can, beer can, 6-32 nuts and bolts, wood screws, black paint, scraps of metal, plywood for carrying case	0.80

from falling out of their compartments.

Note the sheet metal shield over the pilot light and, next to it, the metal cover that shields the power socket lugs. Don't skip this shield! Remember the 4,250 volts lurking there within easy knuckle reach!

**Operation of the snooperscope** is very simple. If you don't get a satisfactory image according to the following procedure, check your wiring for misplaced connections.

Turn on the power and snap on the infra red light. You won't see the invisible light, but you can feel heat in front of the filter.

Focus the objective lens by moving the rear metal tube back and forth, then adjust the eyepiece for the sharpest possible image. Now rotate the electrostatic focus knob on the power pack to further sharpen the image. A photographic red filter placed over the objective lens will increase sharpness when blue and ultra-violet light is also present.

You will see a green image that is surprisingly clear and sharp. However, don't expect to see the same degree of sharpness obtained with orthodox camera and other lens systems using visible light.

Using the recommended lamp, the "reach" of the snooperscope is about 150 feet. A more powerful source of infra red light would, of course, enable you to see objects further away. The objective-eyepiece combination described will provide 2 1/2 X magnification. Other lens systems can be used to increase the degree of magnification.

**Applications.** Naturalists and campers will find the snooperscope an ideal instrument with which to study the habits of noc-

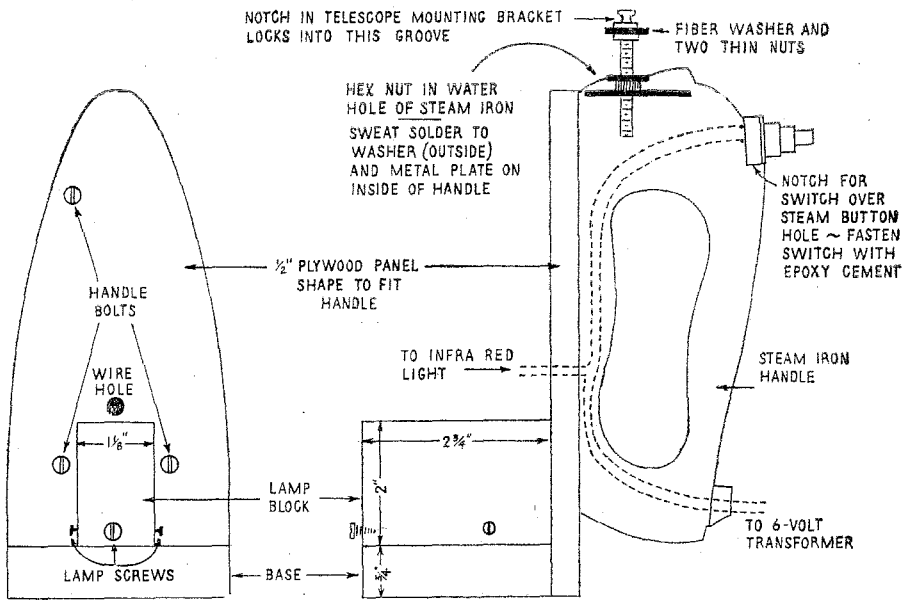

FIG. D: Handle assembly

## Snooperscope

turnal wildlife. Unlike an ordinary flashlight, the invisible infrared beam will not frighten away the animals under observation

Another useful application is in photography of wild animals. The snooperscope should not be used as part of a camera system to actually photograph the animals, which should be done with orthodox equipment.

However, the snooperscope can be a valuable observation device.

Many wildlife pictures are made by setting up a photoelectric or mechanical trip mechanism that sets off flash bulbs and camera when the animal walks into a specific spot. But this is a chance proposition, and you are as likely to get the animal going away from, as coming toward the camera.

With a snooperscope you can observe the animal from a distance and trip the shutter when the creature is in the best possible position. Every shot can be a good one.

**Two-legged prowlers.** The housewife who is frequently left alone at home when her husband is off on business trips is likely to feel uneasy when she hears strange sounds outside at night. With a snooperscope she could scan the property without turning on outside lights. If it is a cat or dog, she can relax; if it is a two-legged prowler, she can call the police who can cope with the unsuspecting intruder.

If you live in an area where it is wise to check the identity of a night visitor before opening the door, use the snooperscope as an invisible security guard. Position the light where it illuminates the doorway, and the telescope where you can secretly observe the location. You can thus identify the visitor without turning on outside lights; if it is an

(Continued on page 95)

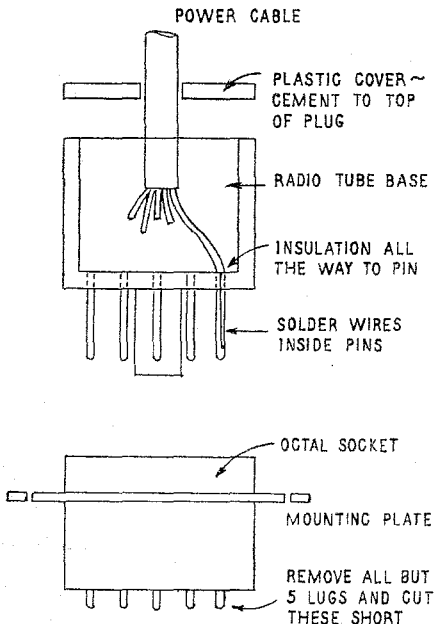

FIG. E: High voltage connector

undercoat and two coats of enamel. Apply white shellac only on the inside of the wheel-boxes. When paint is thoroughly dry, install the tail and stop lights, wiring and license plate and hang the rear and wheelbox doors.

The canvas cover or tent should be made from 10-oz. preshrunk weather and mildew treated canvas (Fig. 21). You can probably save yourself much trouble by having your local awning shop make this part of *Handy Andy* for you. In order for the fasteners at the ends of the left wing to clear the angle weatherstrips on the right wing, it is necessary to locate them on the *inside* of the 1x2 transverse support frames (Fig. 21). Match these fasteners with grommets set into 3x24-in. canvas flaps sewed to the inside of the cover 6 in. up from the bottom edge. There is also a 4-in. no-draft shirt-tail flap of canvas left around the inside of the bottom hem. Along the bed-wing edges, use canvas fasteners of wood-screw type and pilot drill clearance holes for them through the metal angle along the edges. Where the plywood is not backed up by bracing, use fasteners attached with two short wood screws or small bolts. Fasteners will be available from the tent or awning maker.

The "grub boxes" are simply made from ½-in. plywood backed up with ¾x¾-in. molding. The 15x17x42-in. size allows you to stack them on top of each other to form a 30-in. table or stove rest (Fig. 22). Placed separately along left side, they form a bed extension. The boxes store food supplies and utensils so you can quickly set up a kitchen outside in good weather or inside if the weather turns bad.

To take your boat along atop the folded trailer, mount a pair of old washing-machine wringer rolls on brackets made up from ¼x3x3-in. angle iron 6 in. at the rear (Fig. 23). Roller mounting angles should clear the bed wings when they fold out. Padded 2x4x12-in. cradles support the boat at the front.

● Craft Print No. 200 in enlarged size for building Handy Andy is available at \$3. Order by print number. To avoid possible loss of coin or currency in the mail, we suggest you remit by check or money order (no CODs or stamps) to Craft Print Div., SCIENCE & MECHANICS, 505 Park Ave., New York, N. Y. 10022. Please allow three to four weeks for delivery. Special quantity discount! If you order two or more craft prints (this or any other print), you may deduct 25¢ from the regular price of each print. Hence, for two prints, deduct 50¢; three prints, subtract 75¢, etc. Now available, our new illustrated catalog of do-it-yourself plans, 25¢.

## Snooperscope

(Continued from page 68)

undesirable, you need not let him know that you are at home.

Farmers and ranchers may find the snooperscope a practical device for observing predators that harass livestock, chickens, etc. Ordinary lights will scare off such pests before they are properly identified, whereas their movements can be easily observed with a snooperscope and more effective countermeasures can be taken.

If you have trouble with vandals—perhaps only with malicious Halloween pranksters—your snooperscope can convert unidentifiable shadows in the dark into recognizable images.

**In the theatre.** If you manage a theatre, and you are troubled by customers who create disturbances, use the snooperscope to spot the hooligans in the crowd. They will be unaware their antics are being observed.

A more pleasant theatre application of the snooperscope—in both professional and amateur productions—is to study audience reactions in the dark as the play or other performance progresses. These observations may provide clues for smoothing the production.

And you can perform some startling theatrics with the snooperscope right at home. Hide the equipment in a convenient closet or cupboard before your guests arrive. When all are present, seat them at one end of the room and turn out all the lights. In the pitch

dark, you can describe every little action of each individual on the far end of the room. Most people are unfamiliar with the snooperscope, and will be dumbfounded by your ability to see in the dark!

**Communication.** With two sets of snooperscopes, you can blink invisible Morse code signals over a distance of a mile or more. Fit each infra red lamp with a momentary doorbell type switch that lights the lamp only when pushed. While you blink the invisible signals, your distant partner can detect them.

**Experimental uses.** The snooperscope has virtually unlimited applications in experimental projects. You can explore infra red luminescence of minerals. Document forgeries can often be detected with infra red light. And many colored objects react strangely to the invisible light; for example, some black textiles will appear "white" when viewed with the snooperscope, while others appear very dark. The difference is due to the use of different types of dyes in coloring the materials. Uneven, poor-quality dyeing of fabrics can often be spotted.

You can also attach the image tube to a microscope and greatly broaden your observation because many substances react very differently to infra red light than they do to visible light. Infra red penetrates deeper into some materials (e.g. animal tissues) and permits examination below the surface. ■