

Rapidly Increasing Application of Intranet Technologies for SCADA (Supervisory Control and Data Acquisition System)

Hideki Hayashi Yoshiki Takabayashi Hisashi Tsuji
Power System Division
Power Systems & Services Company, Toshiba Corporation.
1, Toshiba-Cho, Fuchu-Shi, Tokyo 183-8511, JAPAN

Masahiko Oka
Fuchu Operations-Power Systems
Power Systems & Services Company, Toshiba Corporation.
1-1, Shibaura 1-chome, Minato-Ku, Tokyo 105-

Abstract— The adoption of Internet and Intranet technologies has been rapidly spreading in recent years, and existing systems are being replaced with new systems based on these new technologies. At changing environment of the power system industry, in 1999 Toshiba announced a concept of new middleware for power system network control systems including energy management systems(EMS), supervisory control and data acquisition systems(SCADA), and distribution management systems(DMS). This new middleware is based on latest Internet and Intranet technologies, offering the real-time operation and high reliability required for network control systems.

Presently, several systems are being manufactured, and some of which are already at the stage of commissioning tests. This Paper focuses a SCADA system for the Ultra High Voltage equipment pilot plant of Tokyo Electric Power Corp.(TEPCO) which has been working since December.2000, and uses Intranet technologies, with an emphasis on a functional overview and the features of the newly developed system.

Index Power system monitoring, Power system control, SCADA systems, Communication systems, Internetworking, Distributed database management system

I. INTRODUCTION

SCADA for power system was developed in the 1960's and has been improved since then. The architecture of SCADA changed in the philosophy of computing in organization, from the mainframe-dominated, centralized computing systems to network-based distributed computing in the early of 1990's[1]. The modern SCADA that is called open distributed systems has designed based on this new architecture. Fundamental features of open distributed systems that distinguish it from the previous design are the use of a redundant, industry-standard, local area network(LAN) and the distribution of functions among several computers or workstations on the LAN. Another feature of it is the use of

RISC processing, which implies the UNIX operation system, which in turn implies TCP/IP communications protocol. Then this architecture is called the RISC-UNIX-TCP/IP model and applied to the majority of the latest SCADA.

Internet/Intranet technology has undergone tremendous change and been applied to various field. Although these enabling technologies have reached far into our work and home environments[2][3], they have not been utilized within SCADA yet. The important problems for Intranet-Based SCADA to be solved are real time performance and reliability of supervisory control. Toshiba Co. developed the middleware to resolve these problems. The developed middleware includes the distributed database management system for main-memory data, multicast communication based on Internet Protocol(IP), wide area cluster system and so on[4]. According to the result of this development, presently, several systems are being manufactured, and some of which are already at the stage of commissioning tests. This Paper focuses a SCADA system for the Ultra High Voltage equipment pilot plant of Tokyo Electric Power Corp.(TEPCO) which has been working since December.2000, and uses Intranet technologies, with an emphasis on a functional overview and the features of the newly developed system.

II. SCADA SYSTEM USING INTRANET TECHNOLOGIES FOR THE UHV EQUIPMENT PILOT PLANT OF TEPCO.

Next-generation substation supervisory control system is divided into three control levels, which are a Bay level (substation yard circuit unit), a Station level (substation unit), and a Remote Control center level (SCADA place level). In accordance with a global trend against the background of the technology, such like computer technology, communication technology, software technology, which was excellent in recent years, it is combined organically in a network and those levels perform a part for the optimal function.

In the Tokyo Electric Power Co., Inc. UHV equipment pilot plant, composition of GIS (Gas Insulated Switchgear) of future 1,000kV electric power system sake, a transformer, and a protection control system. Also in this project, verification of a subject are performed.

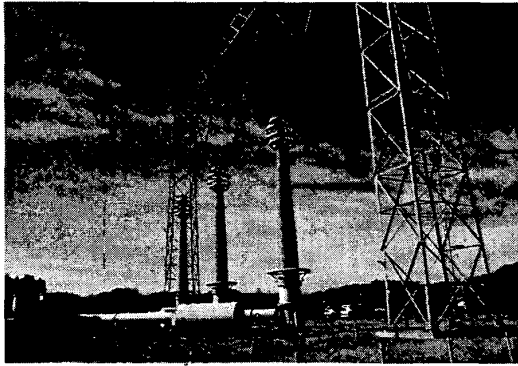

Fig.1 The Ultra High Voltage equipment pilot plant of Tokyo Electric Power Corp.(TEPCO).

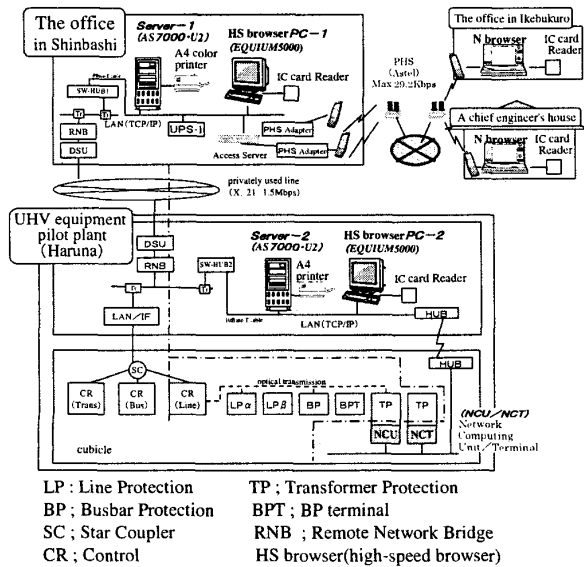

Fig.2 Configuration of UHV substation

The Tokyo Electric Power Co. Inc. and Toshiba Co. developed the system which performs supervisory control of this pilot plant equipment with the application of Intranet technology in consideration of the global trend of the above-mentioned next-generation substation supervisory control system, and started verification of the component engineering shown below from December 1st, 2000.

- (1) The application possibility of the Intranet technology to a SCADA system
- (2) Evaluation of the implementing Optical SC (Star Coupler) in a substation, instead of conventional global standard LAN (Ethernet , TCP/IP (Transmission Control Protocol/Internet Protocol)) (especially,evaluation of optical Ethernet and optical HUB)
- (3) WWW (World Wide Web) server are placed in the UHV equipment pilot plant and the office in Shinbashi, and can

be backed up by each other.

- (4) The protection control function in which Intranet technology is applied (remote employment / maintenance function)

The appearance of the UHV equipment pilot plant is shown in Fig.1, the composition figure of this system is shown in Fig.2, and a system functional outline is shown in Table 1.

TABLE I
Functions of UHV substation control system

Functions	Functional outline
Power System Monitoring	Status data processing
	Analog data processing
	Network Monitoring
Supervisory Control	Control command
	Select-before-operate device control
	Incremental device control
	Automatic supervisory Control
Historical recording	Timetagged status recording
	Monthly, Daily, Hourly, recording
	Archive storage (Saving on CSV format)
And others	Configuration control
	Time synchronous capability
	Display note pad
NCT relay status monitoring on web Browsers	
NCT relay operation settings on web Browsers	
NCT relay status patrol agent	

CSV ; Comma Separated Value
NCT ; Network Computing Terminal

Next, the feature of this system is described.

1) Software configuration

Fig.3 shows software configurations of servers, HS browser(high-speed browser), N browser(normal-browser) and M browser(mobile-browser) in UHV substation control system. SCADA applications are installed in servers, but not in HS browser, N browser and M browser.

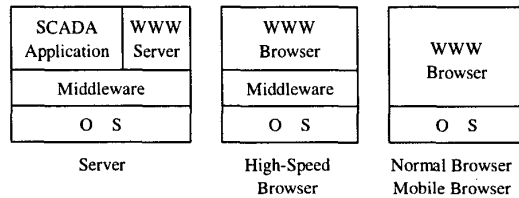

Fig.3 Software Configuration

Middleware consists of HP-MW(High-Performance Middleware group), HR-MW(High-Reliability Middleware group) and SM-MW(Security Management Middleware group) [4].

2) Supervisory control by browser / user interface

As an example of a display of this system, a system overview display is shown in Fig. 4, and a transformer tap control display is shown in Fig. 5.

An operator performs the check of network state conditions, result of supervisory control commands, and record data etc. with the screen displayed on the WWW browser.

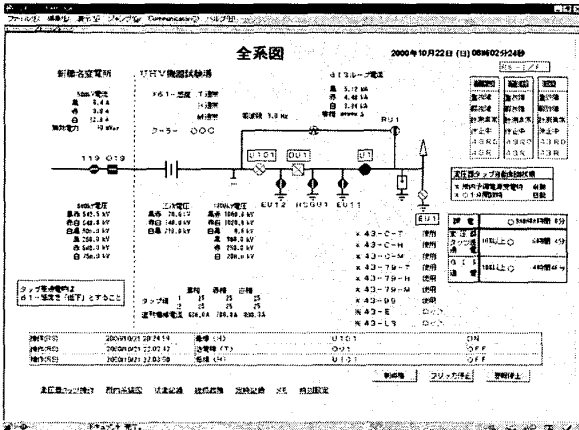

Fig.4 Example of System overview display

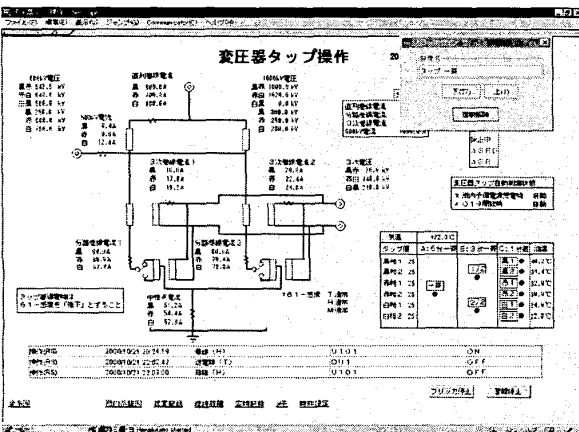

Fig.5 Example of Transformer tap control display

3) Real time screen display

When updating the once displayed screen by the newest information in the regular browser, usually "a re-call" for it is required to be operated. In the system of which real-time performance is required, like a supervisory control system, it is necessary so that the newest information is always displayed on the screen displayed. In this system, this demand is realized by the function of middleware.

Fig.6 shows configuration of HP-MW. Whenever contents in the server are updated by SCADA applications, HP-MW distributes only updated part of it from the server to every

client by using multicast communication based on IP. Then HTTP Push Proxy updates local contents upon receiving distributed data and keeps it. It sends local contents to WWW browser upon request. Data Table Proxy also keeps, updates the replication of data table and enables Java applets to access it. HP-MW automatically requests contents to WWW server when contents is not in it. In this system, the distributed database management system for main memory data was developed and installed. It manages the data for SCADA applications and replica of that data.

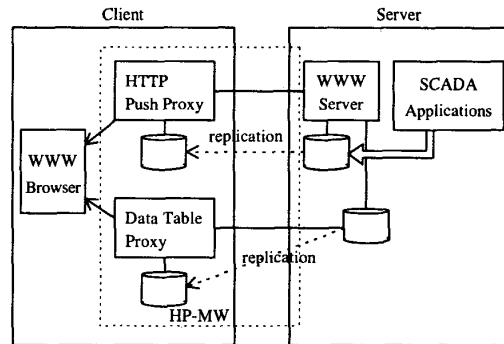

Fig.6 High-Performance Middleware group

4) High-speed Browser and Normal Browser

As a terminal (client) used by this system, both HS browser (high-speed browser) and N browser(normal-browser) can be used properly. The HS browser is installed in the place which needs real-time performance. The N browser can be installed in the place which just needs to refer to a non-critical information, which permits the inferior speed of display. In this system, a high-speed browser is installed in Haruna and Shinbashi, and the N browser is installed in Ikebukuro.

Although N browser has not incorporated special middleware or special application, it is also connected to the same network. Carrying out URL starting, and the general reference system function of this system are usable. As the matters of fact, with consideration,security, it is secured by the below-mentioned method.

Therefore, N browser becomes very effective when serving information for a related section located. widely. HS browser is possible to use also as a regular terminal (PC) connected with the network.

5) The remote backup system which installed the server in the separate place

In this system, the two servers were installed at 2 different sites, one in UHV substation control system in Haruna, and other in the office in Shinbashi, which is how the remote backup system is realized. Moreover, they are connected with the 1.5Mbps communications network which is owned by the Tokyo Electric Power Co., Inc. between the examination site in Haruna, and the office in Shinbashi. Therefore, continuation

of a function is possible for this system even when one of the two's server stops by the system failure, maintenance, etc.

6) Access Control by Integrated Circuit Card

Setting the right to access as WWW contents correctly requires time and lot of effort. Moreover, in the data handling on a network, it is important to assure security. In this system, security management middleware was used and the above-mentioned subject was solved easily.

In this system, three kinds of cards with rights such as A, B, and C, are applied. A is the card which can only be supervised. B is the card which can be supervised and controlled. C is the card which can change control authority.

7) Monitoring at home by PHS

In this system, the chief engineer can check the situation of the UHV equipment pilot plant from the personal computer of his house in an emergency. In addition, the communication circuit is using PHS/PIAFS (PHS Internet Access Forum Standard) which is mobile communication by radio wave of Tokyo Telecommunication Network Co. (Astel). Although screen display speed is slow because of mobile computing, it is very effective in an emergency.

III. CONCLUSION

Only with the technology of general-purpose Internet/Intranet, indispensable real-time performance and reliability of supervisory run short by supervisory control. However these problem will be resolved by the middleware developed this time. Thereby, UHV substation control system proposed in this paper, was able to have flexibility and expandability which has spread with the Internet/Intranet. Although the system introduced this time is only an example, this technology thinks increasingly that it spreads also in the field of supervisory control system from now on.

IV. REFERENCES

- [1] T.E.Dy-Liacco, "Modern Control Centers and Computer Networking", IEEE Computer Applications in Power, Vol.7 No.4, 1994, pp17-22
- [2] M.Benda, "INTERNET ARCHITECTURE: Its Evolution from an Industry Perspective", IEEE INTERNET COMPUTING, Vol.2 No.2, 1998, pp32-35
- [3] P.Dreyfus, "THE SECOND WAVE Netscape on Usability in the Services-Based Internet", IEEE INTERNET COMPUTING, Vol.2 No.2, 1998, pp36-40
- [4] Yoshio Ebata, "Development of the Intranet-Based SCADA", IEEE Pes 2000 Winter Meeting

IX. BIOGRAPHIES



Hideki Hayashi was born in Tokyo, Japan, on March 29, 1953. He received his M.S. degree and Ph.D. degree from Tokyo University. He has been working at Toshiba Corporation and is a senior manager in Power Systems & Services Company, Toshiba Co..



Yoshiki Takabayashi was born in Yokohama, Japan, on April 29, 1958. He received He received his bachelor degree from Chiba University. He has been working in Toshiba Corporation and is a senior specialist in Power Systems & Services Company, Toshiba Co.. His special field of interest is research of Energy Management System and SCADA.



Hisashi Tsuji was born in Fukuoka, Japan, on January 24, 1970. He received his M.S. degree from Kyushu University. He has been working at Toshiba Corporation and is a specialist in Power Systems & Services Company, Toshiba Co..

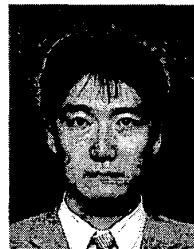

Masaaki Oka was born in Kumamoto, Japan, on Dec 13, 1963. He received his M.S. degree from Yokohama National University. He has been working in Toshiba Corporation and is a manager in Fuchu Operations-Power Systems. His special field are Power Dispatch & Transmission Computer Systems Designing. He is a member of IEEE of Japan, and The Institute of Electrical Engineers of Japan.