

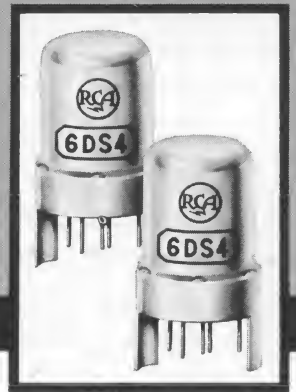

# HAM TIPS



A PUBLICATION OF RCA ELECTRONIC COMPONENTS AND DEVICES

VOL. 25, NO. 4

©1965, RADIO CORPORATION OF AMERICA

FALL, 1965

## Paralleled Nuvistors on 220 Megacycles

By D. W. Nelson, WB2EGZ\*

RCA Defense Electronic Products

The ingenious little RCA nuvistor has been universally accepted for its high performance at relatively low cost. Automated assembly techniques used in its construction have enhanced the uniformity of characteristics from tube to tube. In fact, test matching is generally

unnecessary when using two nuvistors in parallel.

### Objectives of Experiment

A grounded grid amplifier is relatively easy to neutralize and features a very low noise

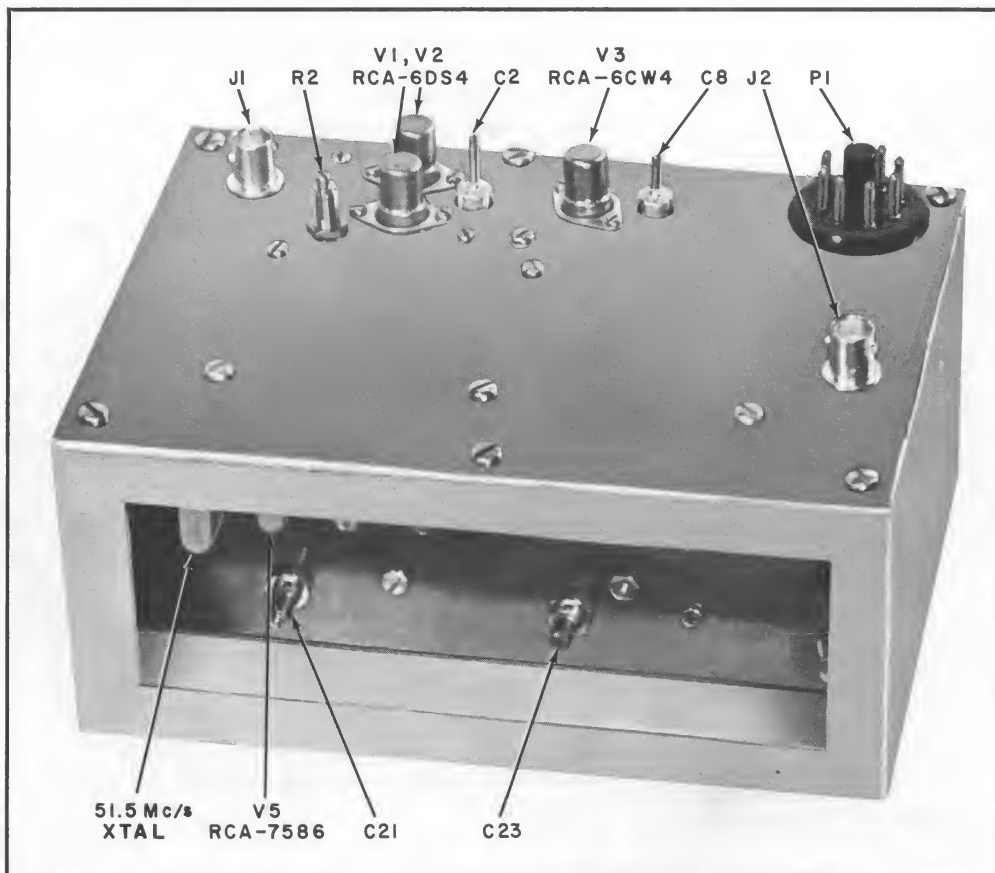

Figure 1: Exterior view of WB2EGZ's 220-Mc nuvistor converter. Note cutout in the chassis to provide easy access to oscillator, multiplier, and IF amplifier tuned circuits. RF stages are tuned from the top.

\*Central Engineering, Camden, New Jersey

figure and a wide dynamic range which minimizes overloading by strong signals. The compromise is a slightly lower gain. The author began his experiment on the premise that a paralleled grounded-grid, front-end could compensate for this loss in gain. The 220-Mc band was chosen because it is generally the "cross-over" band from neutralized grounded-cathode circuits to grounded-grid techniques. As will be shown, the RCA HAM TIPS 432-Mc converter design<sup>1</sup> is easily adapted to "220" service, thereby eliminating many hours of experimentation.

Ideally, perhaps, the 220-Mc converter described in this article should have been made with RCA-8058 double-ended, high-mu triode nuvistors. One objective of this experiment, however, was to obtain better performance on the average Ham's budget. Consequently, the leading role was assigned to two paralleled RCA-6DS4 semiremote-cutoff, high-mu nuvistor triodes. If the RF gain control were omitted, equal performance would be obtainable from RCA-6CW4 high-mu triodes. A 6CW4 was employed for the second stage, also a grounded-grid stage.

Second-stage output is mixed with local oscillator-multiplier output by a 1N830 diode. A 1N82A mixer diode serves equally well.

A low-noise, bandpass IF amplifier that follows, employs the RCA-7587 sharp-cutoff nuvistor tetrode. This stage is identical to that of the earlier-mentioned K2BTM converter.

It has been argued that the diode mixer is unnecessary on this band. The author generally concedes this point, but simultaneously attributes the lack of image interference (another objective) in this commendable circuit to the use of the 14-19-Mc bandpass filter.

The oscillator-multiplier section uses an RCA-7586 medium-mu nuvistor triode as the 51.5-Mc oscillator and a 7587 as a quadrupler. In the original design, a 6CW4 was employed as the oscillator, but the 7586 favors the circuit with greater output and less critical tuning. Output of the 7587 is more than adequate for injection purposes.

### Circuit and Construction Hints

It is doubtful that any construction-type article can anticipate and answer all the questions which might arise in the builder's mind, however, here are some pertinent items that might prove helpful:

A 5-by-7-by-3-inch aluminum chassis is used as an enclosure (see Figure 1). In the author's experience, thin copper with soldered joints provides the best chassis and shield material. The various shield layouts are illustrated in detail in Figure 5.

All tube sockets have been soldered to the chassis as well as to shields on the RF amplifiers.

Although theory might prove that a grounded-grid stage is self-neutralizing, the short strand of wire connecting the grid to ground is a pickup loop which may introduce feedback. Contact potential of the tube already has biased it into an unstable region which increases the tendency to oscillate.

Shields were necessary on the RF stages of the unit. Good plate-tank capacitors were also required.

One or two additional 10-pf ceramic-disc capacitors in parallel with the feedthrough capacitor ( $C_9$ ) may help reduce any instability in the second RF stage.

In the first unit constructed by the author, front-end stability was achieved without cathode resistors and with grids grounded directly. This stability, however, was not present in the second unit constructed. One method of overcoming the contact potential problem, used with the 6CW4 stage, is to lift the grid off DC ground, bypass it with a 500-pf capacitor, and provide a suitable DC return (47K) to the cathode. The grid-bypass capacitor may be varied to effectively reduce the grid to ground inductance, enhancing stability.

An RF gain control ( $R_2$ ) is a "must" for reducing strong SSB signals to detectable levels. The author also found this control useful in alignment and for optimizing signal-to-noise levels.

For stable operation of the RF stages, close-fitting shields across  $V_1$ ,  $V_2$ , and  $V_3$  sockets are mandatory. Lead dress of the heater ground choke ( $RFC_8$ ) is made close to the socket in such manner that the choke is on the input side of the shield (see Figure 4). If no choke is used on the ground side of the heater, the input is attenuated by heater-to-cathode shunt capacitance to ground. Regardless, direct grounding of the heater of  $V_3$  offers one possibility for stopping oscillation if the shield does not fit tightly.

Button-mica capacitors should be separated from the chassis by star washers in order to insure a good ground.

Constant removal and installation of tubes can result in loosened tube-shell contacts. Builders seeking to avoid this possibility

<sup>1</sup>Filipczak, J. M., K2BTM, "A Nuvistor Converter for 432 Megacycles," RCA Ham Tips Volume 22, No. 3, Fall, 1962.

should consider the use of sockets with fingered shells (Cinch 5NS-3), particularly with respect to  $V_1$ ,  $V_2$ , and  $V_3$ .

In high-frequency operation, it is important to remember that leads should be kept extremely short and sharp bends avoided.

**Alignment Procedure**

Proper alignment commences with the oscillator-multiplier, and the procedure is as follows:

(1) Insert, both, the 7586 ( $V_5$ ) and the

7587 ( $V_6$ ) with the crystal. Using a VTVM across the crystal, adjust  $C_{21}$  for a reading. This reading should approximate  $-4$  volts.

(2) Check the grid-No. 1 voltage on  $V_6$ . A reading of  $-22$  volts should result. If adjustments of  $C_{21}$  and  $C_{23}$  fail to bring grid voltages

within 20% of the aforementioned values, the wiring should be checked. Possible sources of trouble might be bypass capacitors  $C_{19}$ ,  $C_{22}$ , and  $C_{25}$ .

(3) The "B+" now should be turned off and on to ascertain that the oscillator will

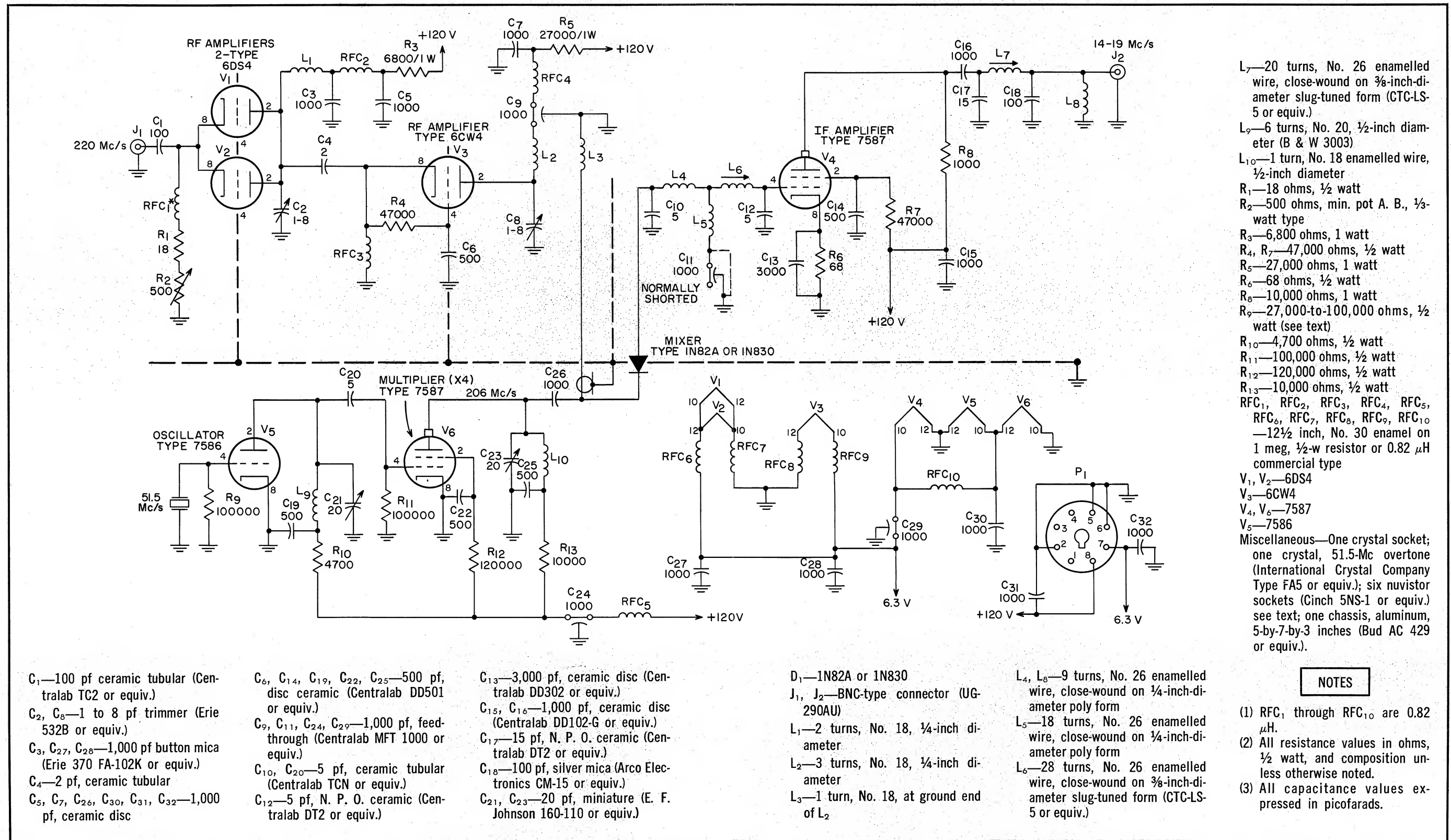

Figure 2: Schematic diagram and parts list of WB2EGZ's 220-Mc nuvistor converter.

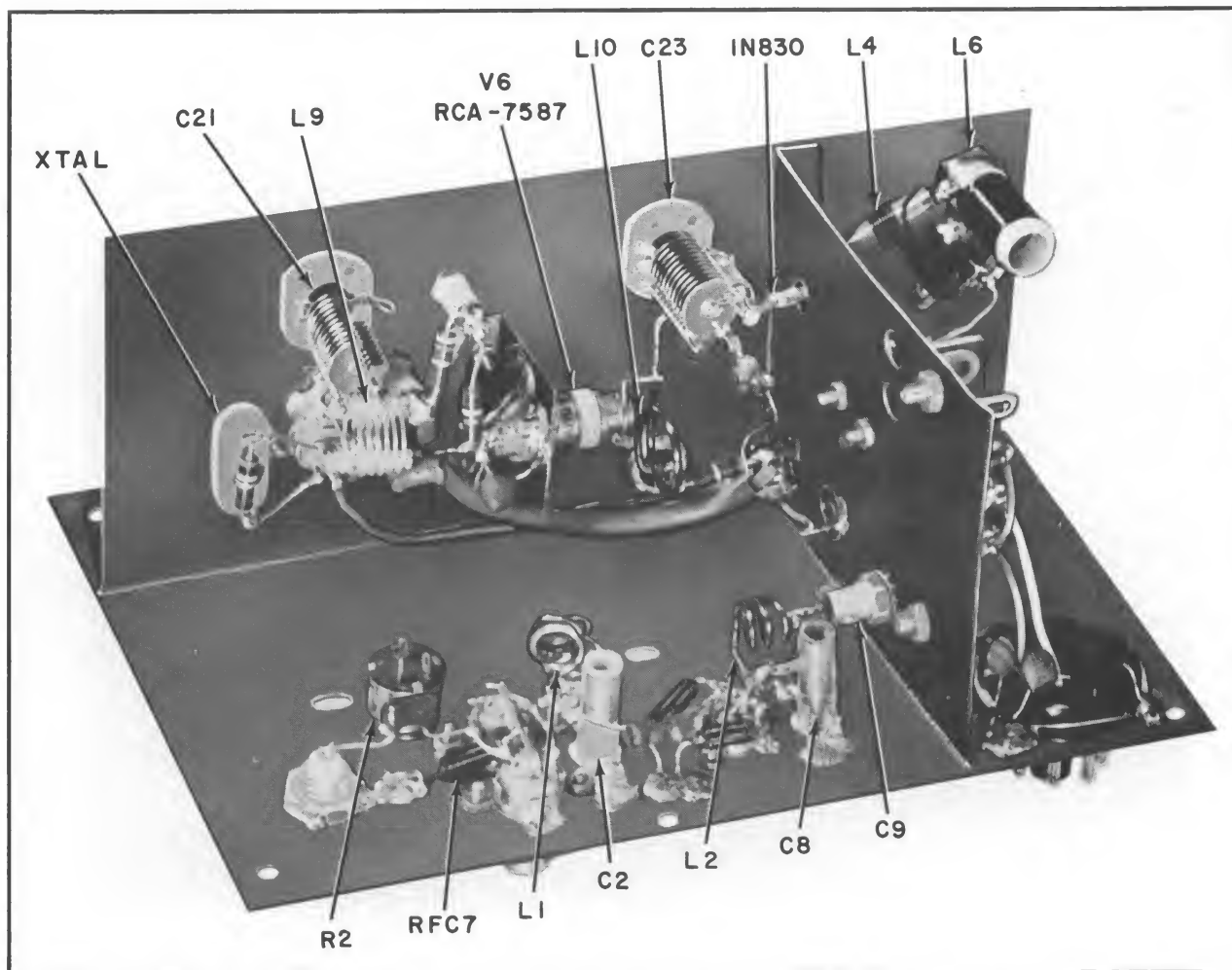

Figure 3: Underside of converter with shielding removed from the RF section. The 1N830 mixer diode is seen feeding through the shield near the 206-Mc plate tank capacitor. RF section wiring shown here is incomplete.

function each time. If it doesn't, decrease the capacitance of  $C_{21}$  slightly. While no problems have been encountered with crystals in three similar oscillators, it seems appropriate to point out that the 100,000-ohm resistor ( $R_9$ ) should be reduced in the event that a crystal fails to oscillate, but to no lower than 27,000 ohms.

Adjustment of the quadrupler may prove more difficult. Two distinct harmonics may be tuned, but only the fourth harmonic is correct. For aligning the quadrupler, connect a milliammeter across  $C_{11}$  (with short removed) and tune  $C_{23}$  for a peak. If two peaks are noted, the one of greater amplitude probably will be 206 megacycles. If a grid-dip oscillator is available, it can be used here to determine the correct frequency. The diode current should now be adjusted to 1 mA by adjusting  $C_{23}$  and/or  $C_{21}$ .

"Rough" tuning of the IF amplifier can be achieved "by ear" when the converter is connected to a receiver.  $L_6$  should be peaked near one end of the *used* portion of the band, e.g.,

14.1 megacycles, while  $L_7$  should be peaked near the other end, e.g., 15.4 megacycles. Although more precise alignment can be obtained through use of a signal generator, the instrument was judged unnecessary in this instance. Retuning while copying a weak signal is the author's favorite sport.

In the event that no strong 220-Mc source is available, a grid-dip oscillator is needed for aligning the RF amplifiers. After  $V_3$  is inserted, adjust its plate tank to approximately 220 megacycles with the tube heaters turned "on." (To couple the tank coil to the grid-dip oscillator, the author employed a link of twisted hookup wire with  $\frac{3}{8}$ -inch loops on each end.) If oscillation occurs with the B+ turned on, slight detuning may be necessary. (Oscillation also can be corrected by inserting a resistor of about 100 ohms between the cathode choke [RFC<sub>3</sub>] and ground.) Now, insert  $V_1$  and  $V_2$  and tune their plate tank in a similar manner. Final peaking can be achieved by an "on-the-air" check.

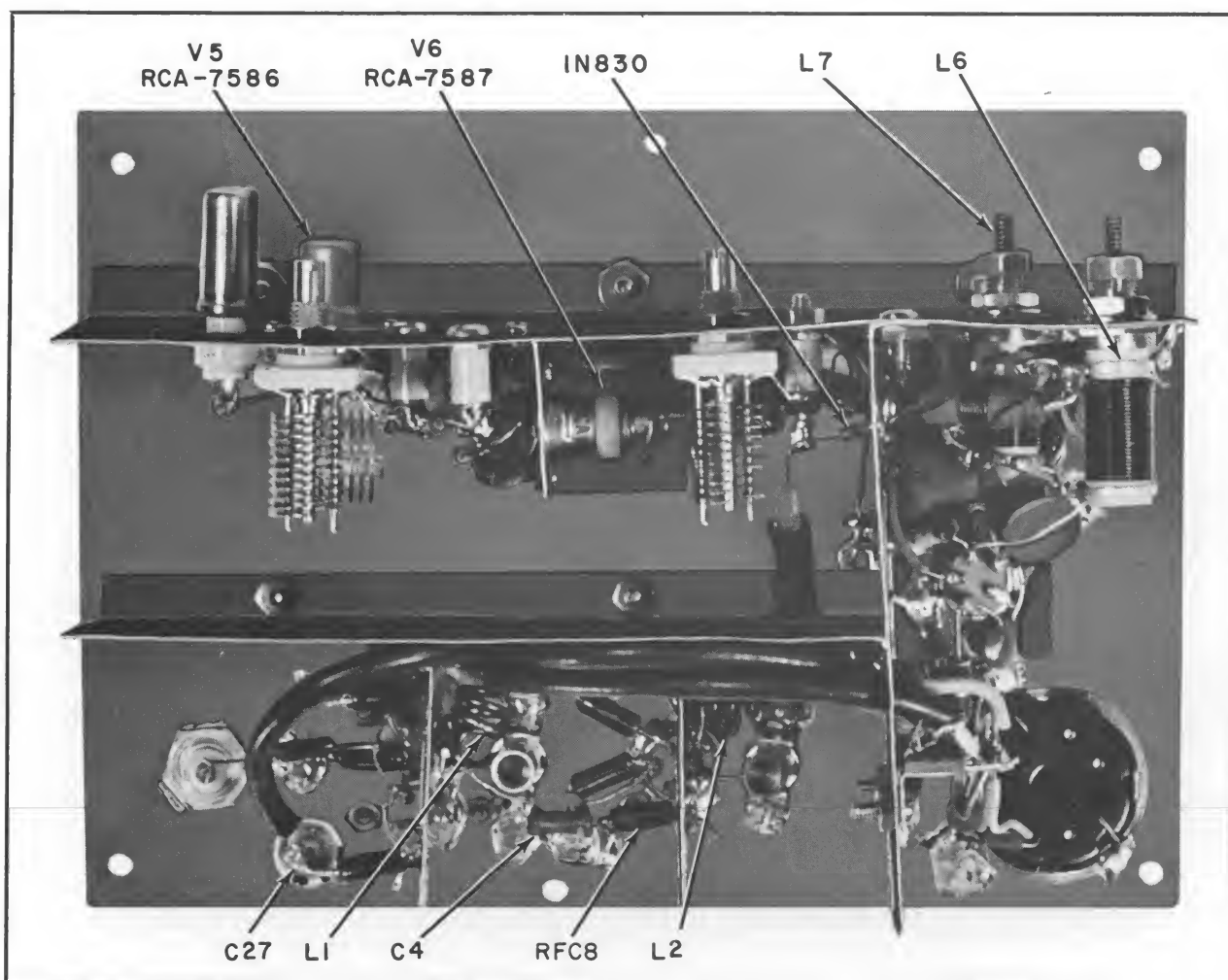

Figure 4: Completed underside of converter showing tube shields and section shields. The plate resistors of the RF stages are in the IF section near the power plug.

### Circuit Performance

Performance of nuvistors at different operating levels has been the subject of several articles in popular radio magazines. It must be emphasized that this article, however, is primarily concerned with the 6DS4 — which accounts for the main difference between the author's results and those achieved by using the 6CW4.

The resistor in the 6DS4 plate circuit ( $R_3$ ) was replaced by a "pot" which was adjusted for optimum readability of a weak signal. Best results were obtained when the pot was set near 6,800 ohms — hence, the value shown. Two paralleled 6DS4's were then tested for  $G_m$  under the same conditions, indicating a level of 23,000 micromhos at a total plate current of 10 mA. Further reduction of  $R_3$  yields a slightly higher transconductance, but achieves no apparent gain in the circuit's performance. Best level of plate voltage on the nuvistors was 49 volts.

A similar test performed on the 6CW4

stage produced less dynamic results. A plate resistor of 27 K appeared to be optimum. Tests to determine the level of the 6CW4 stage showed its  $G_m$  to be 7,200 micromhos at a plate current of 3 mA. In this instance, plate voltage was about 36 volts.

It was suggested that a performance comparison be made by removing one 6DS4 and retuning the plate tank. While this can be done, the results are often misleading. Because the plate resistor has not been changed, *the remaining 6DS4 will not be operating at the same plate current as before*, and the decrease in performance will be greater than if current level had remained the same. A test was made, however, by operating the single 6DS4 at the same current and voltage level. Many previously readable signals were now "in the noise."

The serious experimenter can obtain an improvement in the circuit by carefully matching the input circuit to the antenna. This can be achieved through use of an input tank cir-

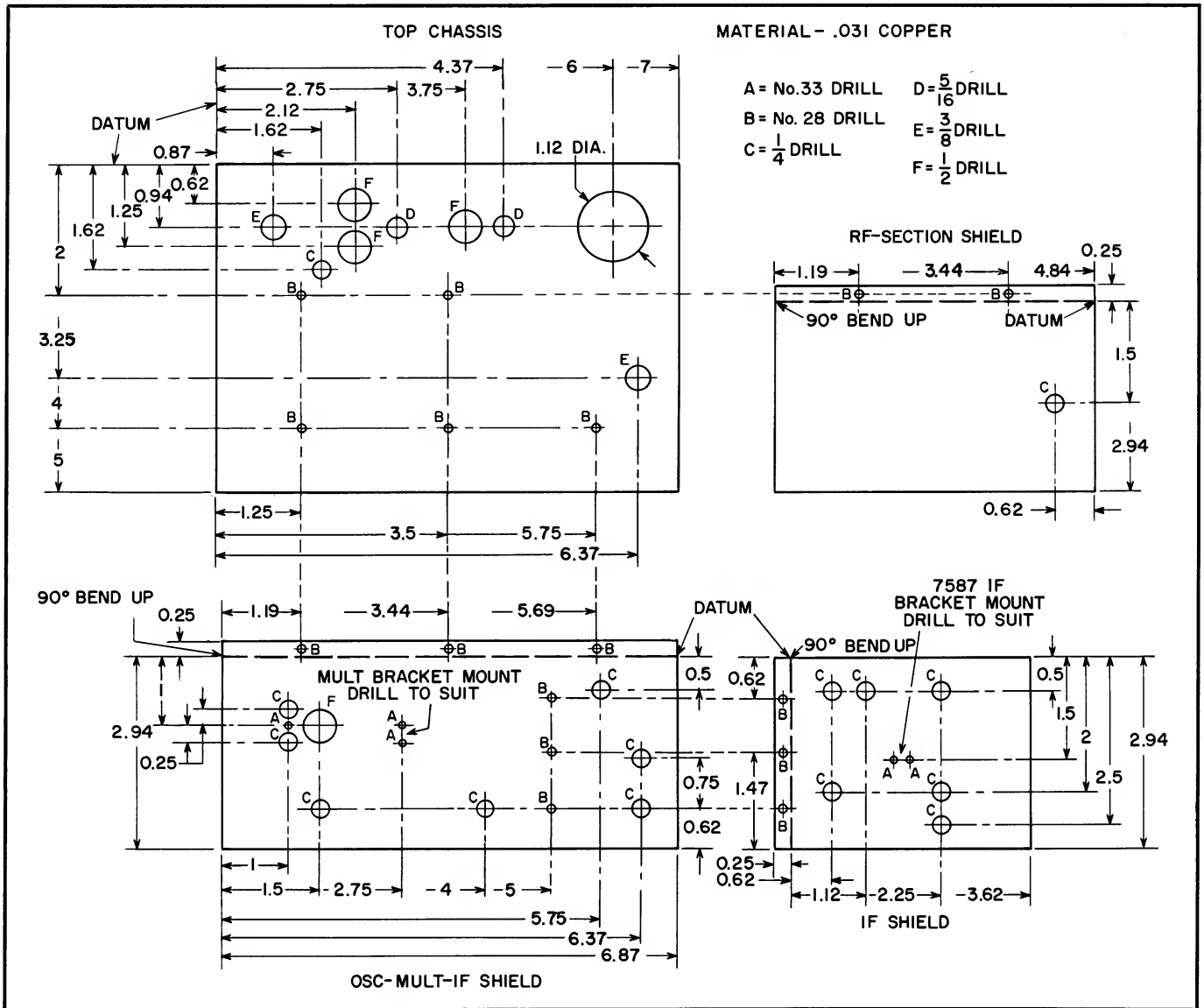

Figure 5: Converter shield layouts and material specifications.

cuit. A simpler approach, however, is to tap  $C_4$  down on  $L_1$  for optimum noise figure. At this frequency, optimized noise figure should coincide with maximum gain.

It should be reported that the converter described in this article has not been plagued by the images and "garbage" so frequently encountered by Hams on the  $1\frac{1}{4}$  meter band. In the Philadelphia area, the first TV interference on the band occurred above 221.6-Mc. Large credit for the high performance of the unit can be attributed to use of high-Q plate tanks in the RF stages, proper shielding, and the filtering of the IF stage.

An "on-the-air" comparison was made with a converter using cascaded 5842's in the grounded-grid configuration. "Ear-test" results and readings of S-levels above the noise showed the performance of the nuvistor converter to be equivalent.

The reliability of this converter has been proved in the past year's performance. It is felt that the design eliminates several problems of other "220" converters, making construction and alignment more practical. For the adventuresome amateur seeking excitement on a new band, this unit is a worthwhile project.

From a personal standpoint, the author found the converter experiment especially rewarding not only for its numerous challenges and interesting results, but for its special endorsement of 220 megacycles — too long neglected as the "orphan" band of ham radio.

**ACKNOWLEDGEMENT.** The author wishes to thank Steve Wojcik for detailed photography and Ken Uhler for his review and comments. To Bob Berger, K2ZNY, and Bill Schaefer, WA2EMB, go special appreciation for their continual interest and many helpful suggestions.

RCA HAM TIPS is published by RCA Electronic Components and Devices, Harrison, N.J. It is available free of charge from participating RCA Industrial Distributors. It is also available on a two-year subscription basis (\$1 for eight issues to cover costs of handling and mailing). Please make check or money order payable to Radio Corporation of America, and remit to "Radio Corporation of America, Section 882, Harrison, New Jersey."

DISTRIBUTED BY  
 GEORGE D. BARBEY CO., INC.  
 READING LEDAHOI  
 LANCASTER POTTSVILLE

PIK IPT  
 ADL 3/24 PD.

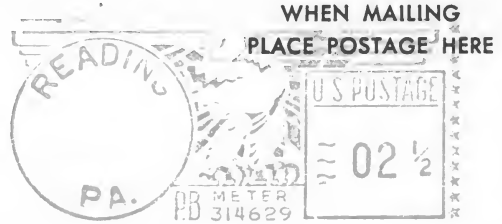

Information furnished by the Radio Corporation of America is believed to be accurate and reliable. However, no responsibility is assumed by RCA for its use; nor for any in-

fringements of patents or other rights of third parties which may result from its use. No license is granted by implication or otherwise under any patent or patent rights of RCA.

Save  
 battery power  
 with the  
**RCA "quick heat"**  
**Beam Power Tube**



Mobile rigs using the RCA-4604 "quick heat" tube conserve filament battery power while operating. It requires *no* filament power in standby, resulting in reduced battery drain... you'll be drawing filament battery power *only* when transmitting.

Similar in capabilities to the famous RCA-6146 Family, the sturdy RCA-4604 has a maximum plate dissipation of 25 watts under ICAS conditions in cw and fm telephony service. At this service, it can be operated with full input to 60 Mc and with reduced input to 175 Mc.

For additional information on the RCA-4604 and its use in mobile rigs, contact Commercial Engineering, Section J-37-M, Harrison, N.J.

RCA ELECTRONIC COMPONENTS AND DEVICES



**The Most Trusted Name in Electronics**